

Bottom view

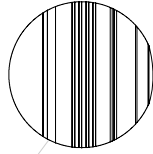

Detail view

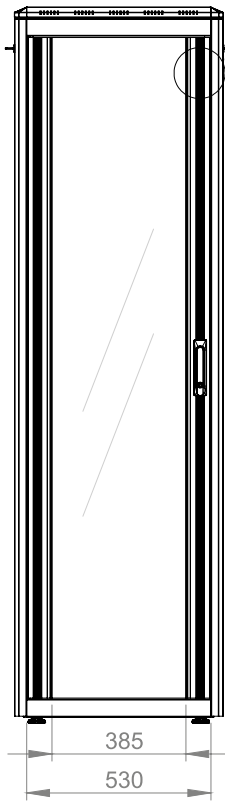

Front view

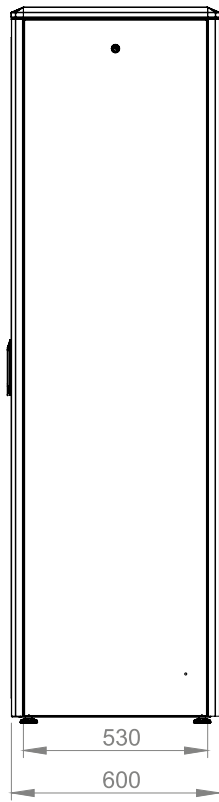

Side view

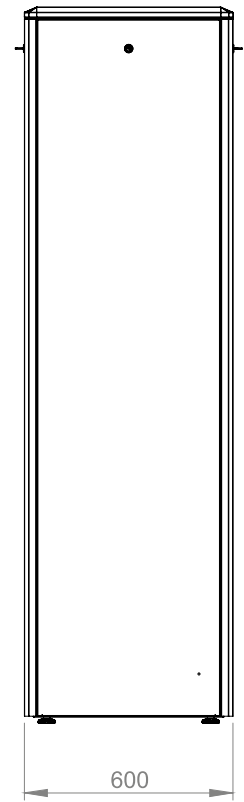

Rear view

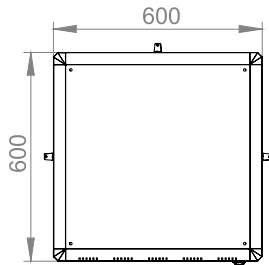

Top view

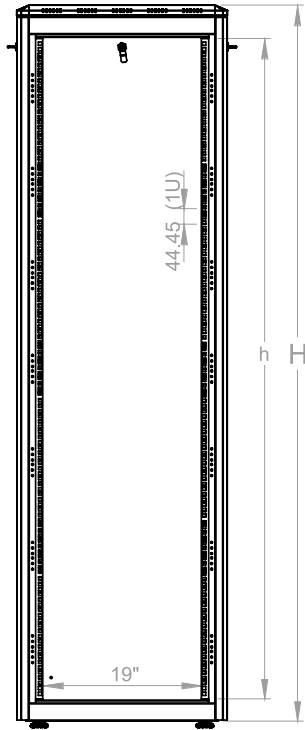

Dimensions in width and height

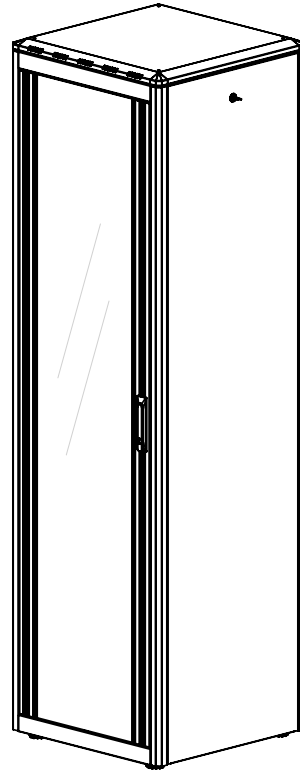

Isometric view

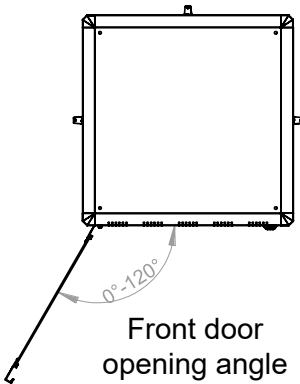

Front door opening angle

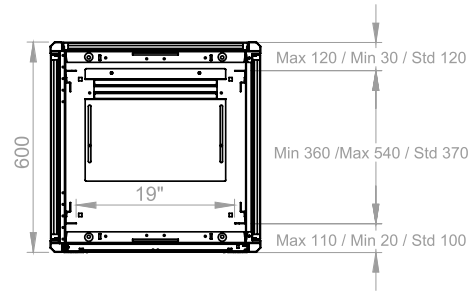

Max/std/min equipment mounting distance

	h	H
<b>12U</b>	533 mm	720 mm
<b>16U</b>	711 mm	898 mm
<b>20U</b>	889 mm	1076 mm
<b>22U</b>	978 mm	1164 mm
<b>26U</b>	1155 mm	1342 mm
<b>32U</b>	1422 mm	1609 mm
<b>36U</b>	1600 mm	1787 mm
<b>39U</b>	1733 mm	1920 mm
<b>42U</b>	1867 mm	2053 mm
<b>45U</b>	2000 mm	2187 mm
<b>47U</b>	2089 mm	2276 mm