

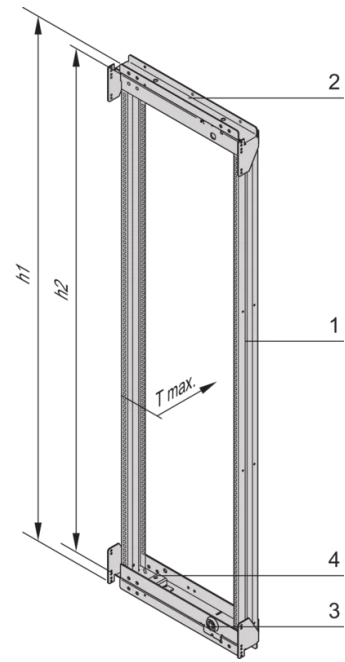

SCHROFF

21630-670 VARISTAR CP SWING CABINET FRAME FOR 600 MM WIDTH, 120°, 29
U

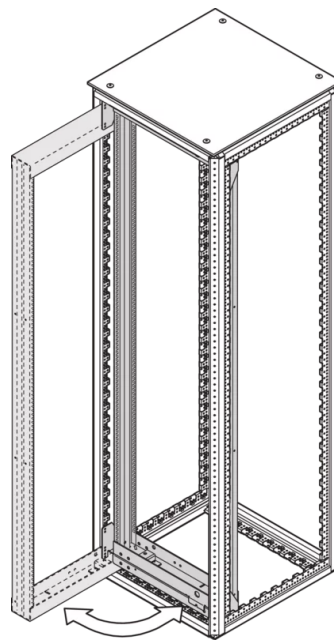
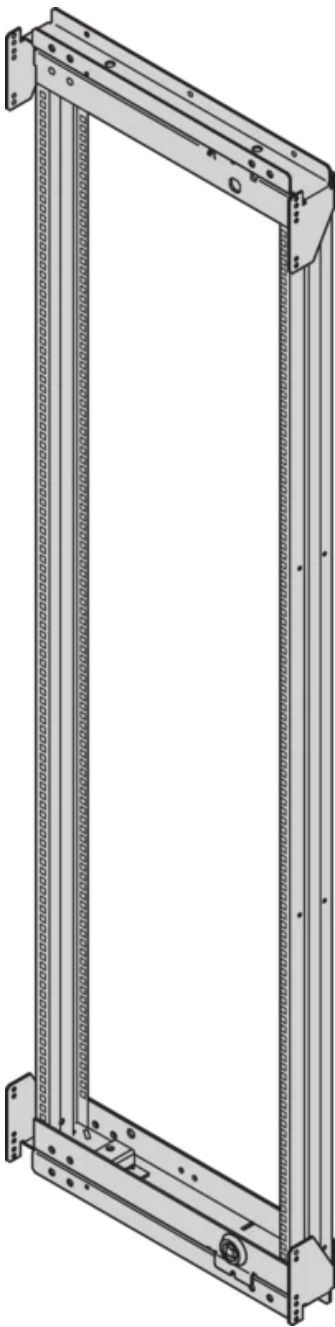

Max Equipment Depth in mm

Cabinet Width in mm	Swing Frame version	Swing Frame mounting position	72 mm recess (standard position)		112.5 mm recess		162.5 mm recess		
			SlimLine	HeavyDuty	SlimLine	HeavyDuty	SlimLine	HeavyDuty	
600	120°	middle	200						
		left/right	380	365			380		
800	120°	left/right	515	500			515		
		middle	430	305	330	305	330		
	160°	middle	475	455	470	455	470	455	
		left/right	475	455	470	455	470	455	

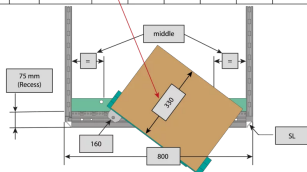

KEY FEATURES

For full height or partial-height mounting

Pivot point can be selected right or left

Can accommodate 19" chassis and 19" subracks (maximum depth 200 mm)

120° hinge, square locks including 2 keys

Load-carrying capacity 150 kg

PRODUCT ATTRIBUTES

Product Type: Cabinet/Rack Frame

Product Family: Varistar CP

Material: Steel

Color: Black Grey

Color Code: RAL 7021

Rack Height: 29 U

Height: 1400 mm

Width: 600 mm

Protection Rating: IP20

ADDITIONAL PRODUCT DETAILS

The 19" swing frame allows the installation of sub-racks while simultaneously making wiring at the rear accessible.

Varistar CP swing frame comes with 150 KG load capacity, 120° movement and flexible pivot point.

By aid of depth members 19" swing frames can be assembled directly on the cabinet frame or in depth-adjustable increments of 50 mm.

Please purchase the grounding kit separately.

North America

All locations

+1.763.422.2661

Chat with us:

schroff.nvent.com

Europe

Straubenhardt, Germany

+49.7082.794.0

Betschdorf, France

+33.3.88.90.64.90

Warsaw, Poland

+48.22.209.98.35

Assago, Italy

+39.02.932.7141

Chat with us:

schroff.nvent.com

Asia

Shanghai, China

+86.21.2412.6943

Qingdao, China

+86.532.8771.6101

Singapore

+65.6768.5800

Shin-Yokohama, Japan

+81.45.476.0271

Chat with us:

schroff.nvent.com

Middle East & India

Dubai, United Arab Emirates

+971.4.378.1700

Bangalore, India

+91.80.6715.2001

Istanbul, Turkey

+90.216.250.7374

Chat with us:

schroff.nvent.com



Our powerful portfolio of brands:
nVent.com **CADDY ERICO HOFFMAN RAYCHEM SCHROFF TRACER**

© 2024 nVent. All nVent marks and logos are owned or licensed by nVent Services GmbH or its affiliates. All other trademarks are the property of their respective owners.

nVent reserves the right to change specifications without notice.