

27230-178 NOVASTAR 19" PANEL/SLIDE MOUNT, 34 U, RAL 7021

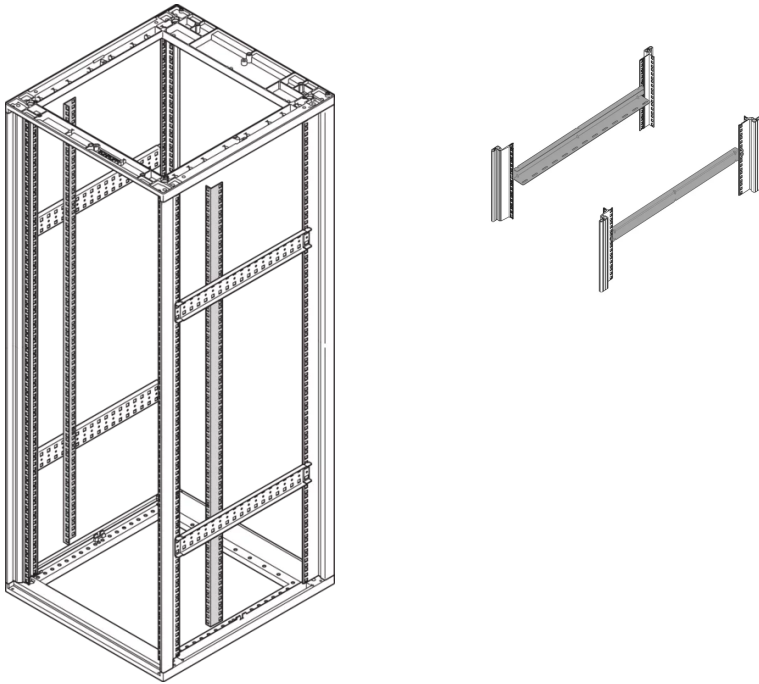

KEY FEATURES

For recessed installation of 19" components

For fitting to depth members (25 mm grid)

Load carrying capacity-400-kg

PRODUCT ATTRIBUTES

Product Type: Slide Mount

Product Family: Novastar

Color: Black Grey

Color Code: RAL 7021

Rack Height: 34 U

Height: 1511.7 mm

Package Quantity: 1

Package Unit: Pair

ADDITIONAL PRODUCT DETAILS

Novastar 19" Panel/Slide Mount Kit with load capacity of 400 kg, ensures easy fitting of 19" components to depth members.

CERTIFICATIONS



North America

All locations
+1.763.422.2661
Chat with us:
schroff.nvent.com

Europe

Straubenhardt, Germany
+49.7082.794.0
Betschdorf, France
+33.3.88.90.64.90
Warsaw, Poland
+48.22.209.98.35
Assago, Italy
+39.02.932.7141
Chat with us:
schroff.nvent.com

Asia

Shanghai, China
+86.21.2412.6943
Qingdao, China
+86.532.8771.6101
Singapore
+65.6768.5800
Shin-Yokohama, Japan
+81.45.476.0271
Chat with us:
schroff.nvent.com

Middle East & India

Dubai, United Arab Emirates
+971.4.378.1700
Bangalore, India
+91.80.6715.2001
Istanbul, Turkey
+90.216.250.7374
Chat with us:
schroff.nvent.com



Our powerful portfolio of brands:
nVent.com **CADDY ERICO HOFFMAN RAYCHEM SCHROFF TRACER**

© 2023 nVent. All nVent marks and logos are owned or licensed by nVent Services GmbH or its affiliates. All other trademarks are the property of their respective owners.

nVent reserves the right to change specifications without notice.