

34813-628 FRAME TYPE PLUG-IN UNIT FRONT PANEL, REFROFIT SHIELDING, 6 U, 28 HP, 2.5 MM, AL, FRONT ANODIZED, REAR CONDUCTIVE

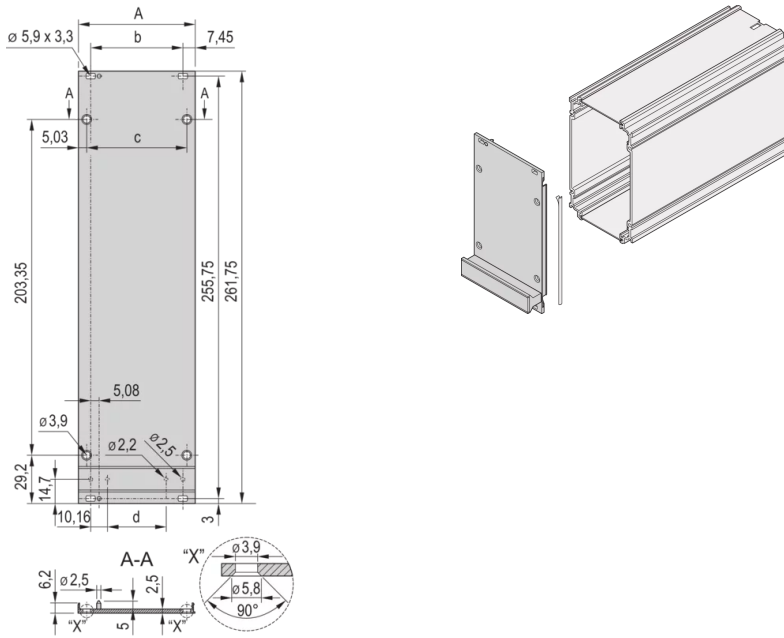

KEY FEATURES

Front Panel for frame type plug-in units PRO, can be modified with Front Panel Configurator

Al extrusion, alignment pin pressed-in, front-anodized, rear conductive

PRODUCT ATTRIBUTES

Accessory Type: Front panel

Material: Aluminum

Front Finish: Anodized

Rear Finish: Conductive

Treated Edges: No

Rack Height: 6 U

Rack Width: 28 HP

Height: 261.75 mm

Width: 141.9 mm

Depth: 2.5 mm

Package Quantity: 5

ADDITIONAL PRODUCT DETAILS

Front Panel for frame type plug-in unit, shieldable.

Please take into consideration that deliveries may be carried out in the stated SPQs (SPQ, e.g. 5 pieces, 10 pieces, 50 pieces, etc.). Differing order quantities (e.g. 2 pieces) may be changed to the next possible delivery quantity = Standard Pack Quantity.

Mounting kit to fix front Panel to plug-in unit, handle to bolt on, clip and screw with plastic sleeve for mounting plug-in unit in subrack or case are included in the item 'Mounting kit for five plug-in units', part number 24812-100.

CERTIFICATIONS



North America

All locations
+1.763.422.2661
Chat with us:
schroff.nvent.com

Europe

Straubenhardt, Germany
+49.7082.794.0
Betschdorf, France
+33.3.88.90.64.90
Warsaw, Poland
+48.22.209.98.35
Assago, Italy
+39.02.932.7141
Chat with us:
schroff.nvent.com

Asia

Shanghai, China
+86.21.2412.6943
Qingdao, China
+86.532.8771.6101
Singapore
+65.6768.5800
Shin-Yokohama, Japan
+81.45.476.0271
Chat with us:
schroff.nvent.com

Middle East & India

Dubai, United Arab Emirates
+971.4.378.1700
Bangalore, India
+91.80.6715.2001
Istanbul, Turkey
+90.216.250.7374
Chat with us:
schroff.nvent.com



Our powerful portfolio of brands:
nVent.com **CADDY ERICO HOFFMAN RAYCHEM SCHROFF TRACER**

© 2023 nVent. All nVent marks and logos are owned or licensed by nVent Services GmbH or its affiliates. All other trademarks are the property of their respective owners.

nVent reserves the right to change specifications without notice.