

## 30809-644 HF FRAME TYPE PLUG-IN UNIT REAR PANEL, CUT-OUT FOR ONE CONNECTOR, 3 U, 14 HP

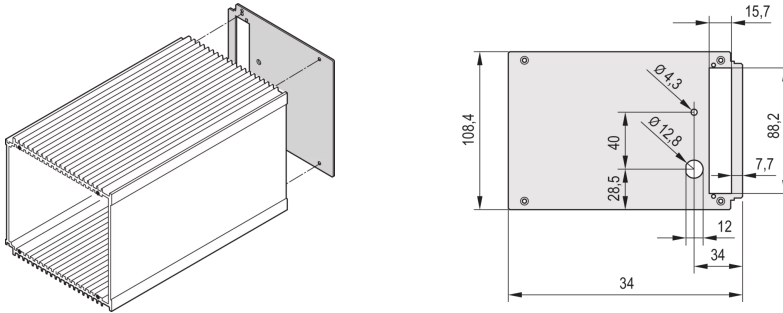

### KEY FEATURES

Rear Panel for HF frame type plug-in unit, with cut-out for one connector

### PRODUCT ATTRIBUTES

Product Type: Side Panel

Type: Rear Panel

Rack Width: 14 HP

Package Quantity: 5

### ADDITIONAL PRODUCT DETAILS

Rear Panel for HF frame type plug-in unit, with cut-out for one connector enable a user to assemble a connector. In accordance with EN 60603-2.

Please take into consideration that deliveries may be carried out in the stated SPQs (SPQ, e.g. 5 pieces, 10 pieces, 50 pieces, etc.). Differing order quantities (e.g. 2 pieces) may be changed to the next possible delivery quantity = Standard Pack Quantity.

Rear Panel for HF plug-in units can be modified with Front Panel Configurator.

The cut-outs in the rear Panel suit the following EN-60603 (DIN-41612) connector types: 7 HPB, C, D, R10 - 28 HPB, C, D, R, F, H, MF, MHRear Panels with cut-outs for connectors reduce effectiveness of EMC sealing.



**North America**

All locations  
+1.763.422.2661  
Chat with us:  
[schroff.nvent.com](https://schroff.nvent.com)

**Europe**

Straubenhardt, Germany  
+49.7082.794.0  
Betschdorf, France  
+33.3.88.90.64.90  
Warsaw, Poland  
+48.22.209.98.35  
Assago, Italy  
+39.02.932.7141  
Chat with us:  
[schroff.nvent.com](https://schroff.nvent.com)

**Asia**

Shanghai, China  
+86.21.2412.6943  
Qingdao, China  
+86.532.8771.6101  
Singapore  
+65.6768.5800  
Shin-Yokohama, Japan  
+81.45.476.0271  
Chat with us:  
[schroff.nvent.com](https://schroff.nvent.com)

**Middle East & India**

Dubai, United Arab Emirates  
+971.4.378.1700  
Bangalore, India  
+91.80.6715.2001  
Istanbul, Turkey  
+90.216.250.7374  
Chat with us:  
[schroff.nvent.com](https://schroff.nvent.com)



Our powerful portfolio of brands:  
[nVent.com](https://nVent.com) **CADDY ERICO HOFFMAN RAYCHEM SCHROFF TRACER**