

24813-342 FRAME TYPE PLUG-IN UNIT PRO KIT, SHIELDED, PERFORATED, MULTIPLE CONNECTORS, 3 U, 42 HP, 167 MM

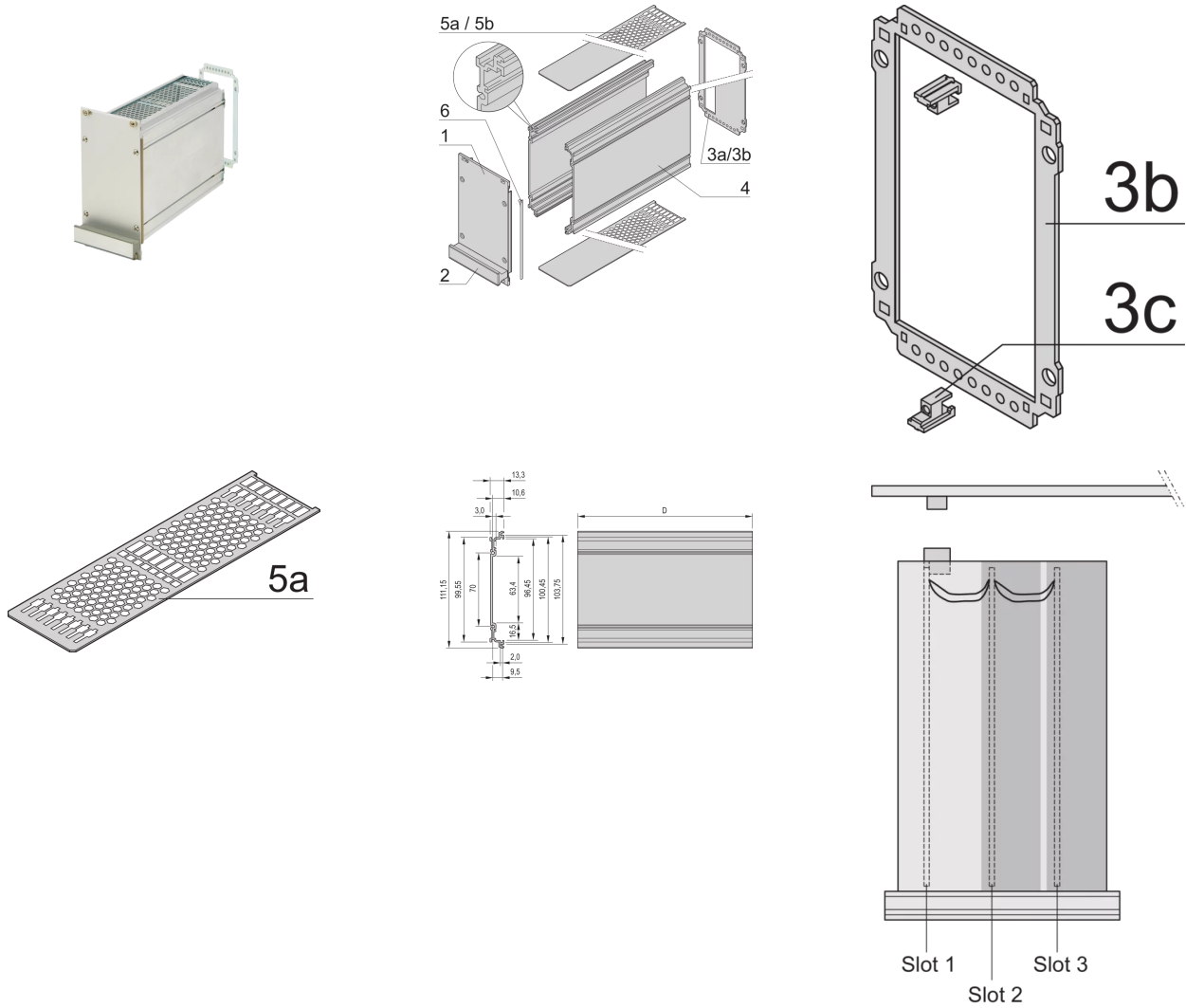

KEY FEATURES

Cover plate with perforation, for guide rails (airflow approx. 60-%)

Rear panel with cut-out for multiple connectors

Extruded side panels with groove to right and left, to insert a PCB (board position in accordance with standard in left side panel only)

PRODUCT ATTRIBUTES

Product Type: Cassette

Type: Frame Type Plug-in Units PRO

Handle Type: Trapezoid

Rack Height: 3 U

Rack Width: 42 HP

Depth: 167 mm

EMC Shielding: Yes

EMC Gasket Type: Textile

Rear Panel Type: Multiple Connector Cut-Out

Cover Plate Type: Cover Plate with Perforation for Guide Rails

Material: Aluminum

Front Finish: Anodized

Rear Finish: Anodized

Cooling: Perforated

ADDITIONAL PRODUCT DETAILS

Protects a PCB against mechanical damage and discharges electrostatic buildup; for Euroboard formats; pair with panel with cutouts for more connectors.

To fit further boards without rear connector, guide rail (part no. 24812-301) and 'Board fixing from slot 2' (part no. 24812-301 + screw part no. 24560-178) are required, 2 guide rails, 2 rear panel holders and board fixing for slot 1 and one slot-2 are already included.

Please-order guide rails-separately.

CERTIFICATIONS



North America

All locations

+1.763.422.2661

Chat with us:

schroff.nvent.com

Europe

Straubenhardt, Germany

+49.7082.794.0

Betschdorf, France

+33.3.88.90.64.90

Warsaw, Poland

+48.22.209.98.35

Assago, Italy

+39.02.932.7141

Chat with us:

schroff.nvent.com

Asia

Shanghai, China

+86.21.2412.6943

Qingdao, China

+86.532.8771.6101

Singapore

+65.6768.5800

Shin-Yokohama, Japan

+81.45.476.0271

Chat with us:

schroff.nvent.com

Middle East & India

Dubai, United Arab Emirates

+971.4.378.1700

Bangalore, India

+91.80.6715.2001

Istanbul, Turkey

+90.216.250.7374

Chat with us:

schroff.nvent.com



Our powerful portfolio of brands:
nVent.com **CADDY ERICO HOFFMAN RAYCHEM SCHROFF TRACER**

© 2023 nVent. All nVent marks and logos are owned or licensed by nVent Services GmbH or its affiliates. All other trademarks are the property of their respective owners.

nVent reserves the right to change specifications without notice.