

24812-971 FRAME TYPE PLUG-IN UNIT PRO, PLAIN COVER, 1 CONNECTOR, 6 U,
21 HP, 227 MM

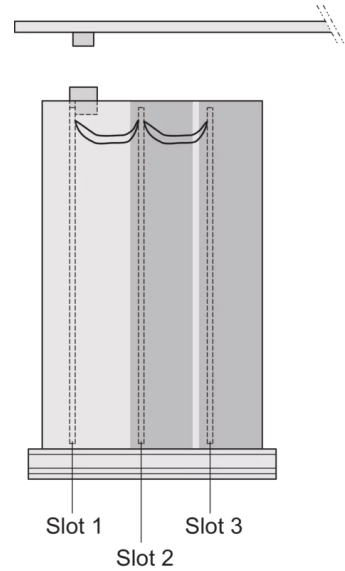
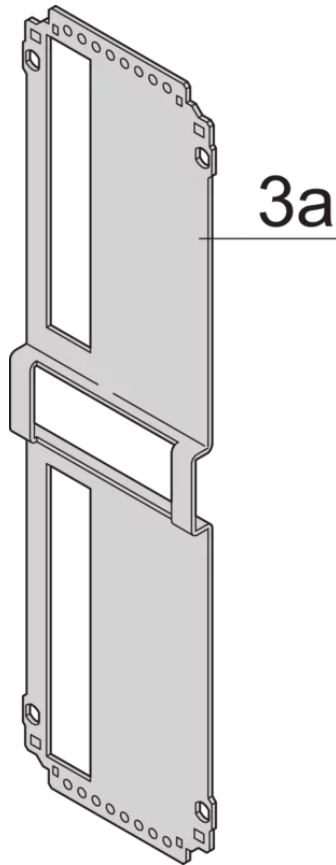
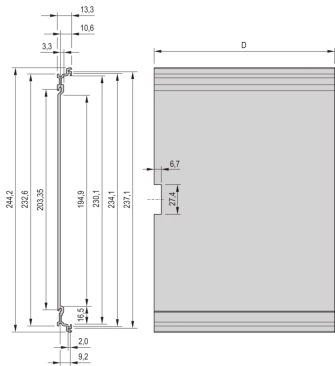
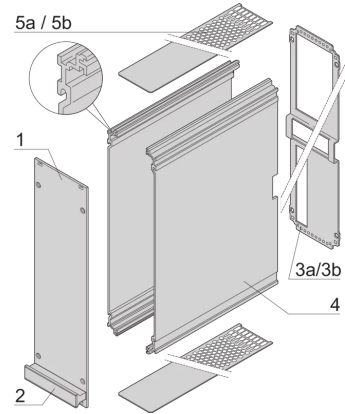
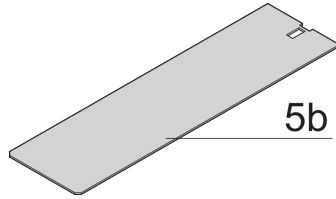

KEY FEATURES

Rear panel with cut-out for single connector (conforms to EN 60603, DIN 41612, construction types: B, C, D, F, H, Q, R, S)

Extruded side panels right and left, with grooves for insertion of a printed circuit board (standard board position is on the left only)

Plain cover plates

PRODUCT ATTRIBUTES

Product Type: Cassette

Type: Frame Type Plug-in Units PRO

Handle Type: Trapezoid

Rack Height: 6 U

Rack Width: 21 HP

Depth: 227 mm

EMC Shielding: No

Rear Panel Type: Single Connector Cut-Out

Cover Plate Type: Cover Plate without Perforation

Material: Aluminum

Front Finish: Anodized

Rear Finish: Anodized

ADDITIONAL PRODUCT DETAILS

Frame type plug-in unit, non-shielded, plain covers, rear panel with cutout for one connector.

CERTIFICATIONS



North America

All locations

+1.763.422.2661

Chat with us:

schroff.nvent.com

Europe

Straubenhardt, Germany

+49.7082.794.0

Betschdorf, France

+33.3.88.90.64.90

Warsaw, Poland

+48.22.209.98.35

Assago, Italy

+39.02.932.7141

Chat with us:

schroff.nvent.com

Asia

Shanghai, China

+86.21.2412.6943

Qingdao, China

+86.532.8771.6101

Singapore

+65.6768.5800

Shin-Yokohama, Japan

+81.45.476.0271

Chat with us:

schroff.nvent.com

Middle East & India

Dubai, United Arab Emirates

+971.4.378.1700

Bangalore, India

+91.80.6715.2001

Istanbul, Turkey

+90.216.250.7374

Chat with us:

schroff.nvent.com



Our powerful portfolio of brands:
nVent.com **CADDY ERICO HOFFMAN RAYCHEM SCHROFF TRACER**

© 2023 nVent. All nVent marks and logos are owned or licensed by nVent Services GmbH or its affiliates. All other trademarks are the property of their respective owners.

nVent reserves the right to change specifications without notice.