

24571-354 RATIOACPRO TIP-UP HANDLE ASSEMBLY KIT, 3 U, 42 HP, 375 MM

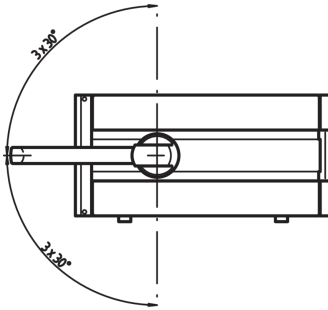
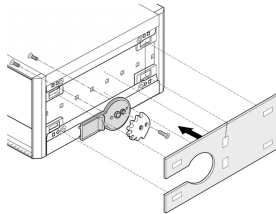

KEY FEATURES

Aluminum side panel powder coated RAL 9006, Adapter and assembly material.

PRODUCT ATTRIBUTES

Product Type: Assembly Kit

Type: Tip-Up Handle Kit

Works With: Cases

Rack Height: 3 U

Rack Width: 42 HP

Depth: 375 mm

Package Quantity: 1

ADDITIONAL PRODUCT DETAILS

The assembly kit must be used if a tip-up handle should be mounted. Standard side covers should be replaced.

CERTIFICATIONS



North America

All locations

+1.763.422.2661

Chat with us:

schroff.nvent.com

Europe

Straubenhardt, Germany

+49.7082.794.0

Betschdorf, France

+33.3.88.90.64.90

Warsaw, Poland

+48.22.209.98.35

Assago, Italy

+39.02.932.7141

Chat with us:

schroff.nvent.com

Asia

Shanghai, China

+86.21.2412.6943

Qingdao, China

+86.532.8771.6101

Singapore

+65.6768.5800

Shin-Yokohama, Japan

+81.45.476.0271

Chat with us:

schroff.nvent.com

Middle East & India

Dubai, United Arab Emirates

+971.4.378.1700

Bangalore, India

+91.80.6715.2001

Istanbul, Turkey

+90.216.250.7374

Chat with us:

schroff.nvent.com



Our powerful portfolio of brands:
nVent.com **CADDY ERICO HOFFMAN RAYCHEM SCHROFF TRACER**

© 2023 nVent. All nVent marks and logos are owned or licensed by nVent Services GmbH or its affiliates. All other trademarks are the property of their respective owners.

nVent reserves the right to change specifications without notice.