

24560-280 FRONT PANEL EMC SHIELDING KIT, TEXTILE, FRONT TO SIDE PANEL, RECESSED, 4 U

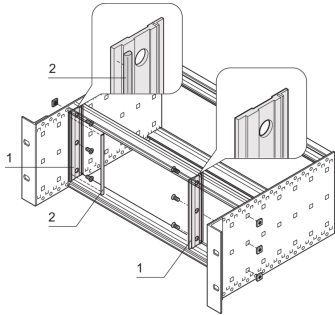

KEY FEATURES

For vertical EMC shielding between depth offset shielded front panels and side panel

PRODUCT ATTRIBUTES

Product Type: Shielding Kit

Product Family: EuropacPRO

Rack Height: 4 U

Package Quantity: 1

ADDITIONAL PRODUCT DETAILS

For vertical textile EMC shielding between recessed mounted shielded front panels and side panel.

CERTIFICATIONS



North America

All locations

+1.763.422.2661

Chat with us:

schroff.nvent.com

Europe

Straubenhardt, Germany

+49.7082.794.0

Betschdorf, France

+33.3.88.90.64.90

Warsaw, Poland

+48.22.209.98.35

Assago, Italy

+39.02.932.7141

Chat with us:

schroff.nvent.com

Asia

Shanghai, China

+86.21.2412.6943

Qingdao, China

+86.532.8771.6101

Singapore

+65.6768.5800

Shin-Yokohama, Japan

+81.45.476.0271

Chat with us:

schroff.nvent.com

Middle East & India

Dubai, United Arab Emirates

+971.4.378.1700

Bangalore, India

+91.80.6715.2001

Istanbul, Turkey

+90.216.250.7374

Chat with us:

schroff.nvent.com



Our powerful portfolio of brands:
nVent.com **CADDY ERICO HOFFMAN RAYCHEM SCHROFF TRACER**

© 2023 nVent. All nVent marks and logos are owned or licensed by nVent Services GmbH or its affiliates. All other trademarks are the property of their respective owners.

nVent reserves the right to change specifications without notice.