

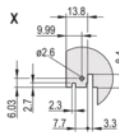

SCHROFF

20848-592 PLUG-IN UNIT KIT WITH IEL HANDLE, SHIELDED, BLACK, 6 U, 4 HP

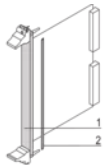
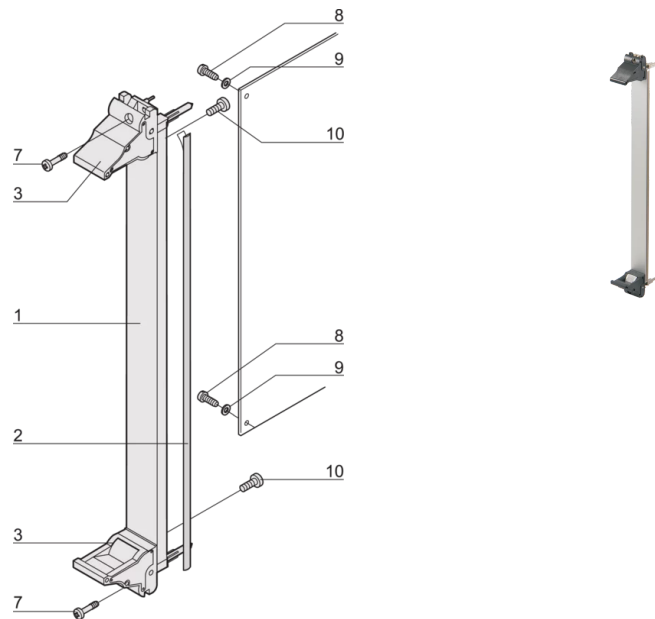
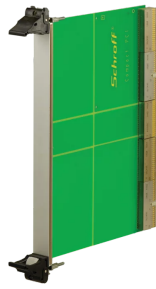

3 HE

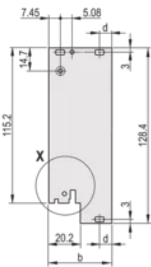
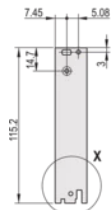

6 HE

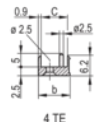
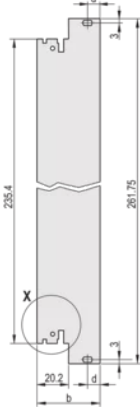

4 TE

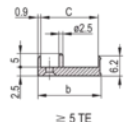

5 TE

KEY FEATURES

U-shaped front panel for textile gasket

Suitable for insertion and extraction forces up to 700-N (per pair)

Enable the installation of a microswitch

Enable the installation of coding pegs in accordance with IEC 60297-3-103/ IEEE-1101.10

PRODUCT ATTRIBUTES

Product Type: Front Panel

Type: Front Panel with Handle (PIU)

Handle Type: IEL

Mounting: Screw-on Front; Screw-on Rear IO

EMC Shielding: Yes

EMC Gasket Type: Textile

Material: Aluminum

Front Finish: Anodized

Rear Finish: Etched

Treated Edges: No

Rack Height: 6 U

Height: 261.8 mm

Rack Width: 4 HP

Width: 20 mm

Complies With: IEC 60297-3-102; IEEE 1101.10; IEC 60297-3-103; IEEE 1101.1/11

Package Quantity: 1

ADDITIONAL PRODUCT DETAILS

Plug-in unit, with IEL inserter/extractor black handle, 6 U, front assembly. The U-shaped front panel enable shielding with a textile gasket.

CERTIFICATIONS



North America

All locations

+1.763.422.2661

Chat with us:

schroff.nvent.com

Europe

Straubenhardt, Germany

+49.7082.794.0

Betschdorf, France

+33.3.88.90.64.90

Warsaw, Poland

+48.22.209.98.35

Assago, Italy

+39.02.932.7141

Chat with us:

schroff.nvent.com

Asia

Shanghai, China

+86.21.2412.6943

Qingdao, China

+86.532.8771.6101

Singapore

+65.6768.5800

Shin-Yokohama, Japan

+81.45.476.0271

Chat with us:

schroff.nvent.com

Middle East & India

Dubai, United Arab Emirates

+971.4.378.1700

Bangalore, India

+91.80.6715.2001

Istanbul, Turkey

+90.216.250.7374

Chat with us:

schroff.nvent.com



Our powerful portfolio of brands:
nVent.com **CADDY ERICO HOFFMAN RAYCHEM SCHROFF TRACER**

© 2023 nVent. All nVent marks and logos are owned or licensed by nVent Services GmbH or its affiliates. All other trademarks are the property of their respective owners.

nVent reserves the right to change specifications without notice.