



# Quick Installation

## Mx-NPAA-Box

Network Power Adapter (NPA) for power supply of MOBOTIX cameras by external power supply units and batteries from 12 to 24 V DC.

- Power supply for MOBOTIX cameras with up to 25 W
- Protection class IP66, -30 to 50 °C/-22 to 122 °F
- Complete set including mounting supplies

# Scope of Delivery

Count	Part Name
-------	-----------

1	Mx-NPAA-Box Order Code: Mx-F-NPAA
2	Stainless steel PZ head screws 4 x 40 mm
2	Stainless steel washers
2	Plastic dowels
1	Screwdriver, small, blue
3	Silicone rubber plugs, white
1	Cable tie

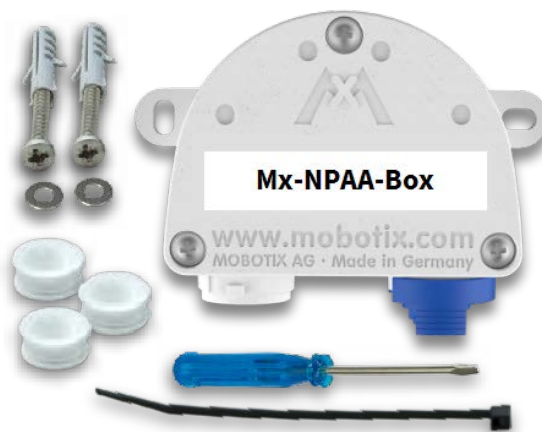

# Installation Instructions

## NOTE!

- The MOBOTIX Mx-NPAA-Box is to be used only as a stationary power supply of MOBOTIX cameras in IP66 environments. The device is only to be used with genuine MOBOTIX parts. Make sure that the power supply is properly protected against any electrical surges, transients, harmonic waves, etc.
- Make sure that you adhere to all relevant laws, regulations and that you fulfill all certification requirements for the intended use.
- Only one PoE end device (e.g. MOBOTIX camera) can be connected to the Mx-NPAA-Box.
- Make sure that the wires of the installation cable are properly twisted and shielded.
- If power is supplied from a battery, make sure to run the plus wire (+) of the power supply through a safety fuse (3 A).
- Torque for cover screws: 0.4 Nm.
- Torque for fastening screws: 0.4 Nm.
- Press the white cable plug (eight-wire plug or cable plug 3 to 5 mm or 5 to 7 mm) into the casing in such a way that the rims stick out equally on both sides.
- The status LED of the Mx-NPAA-Box signals whether the PoE negotiation has been carried out correctly and the camera is supplied with power accordingly (green LED on; see [LED Signals, p. 7](#)).
- The maximum cable lengths between the power supply and Mx-NPAA-Box vary according to the output voltage of the power supply (see [Additional Information, p. 7](#)).

**CAUTION!** Only for MOBOTIX cameras! Using this product to power other devices will void the warranty!

## Standard scenario

In this scenario, the Mx-NPAA-Box supplies power to the MOBOTIX camera via a MOBOTIX patch cable with integrated sealing rings.

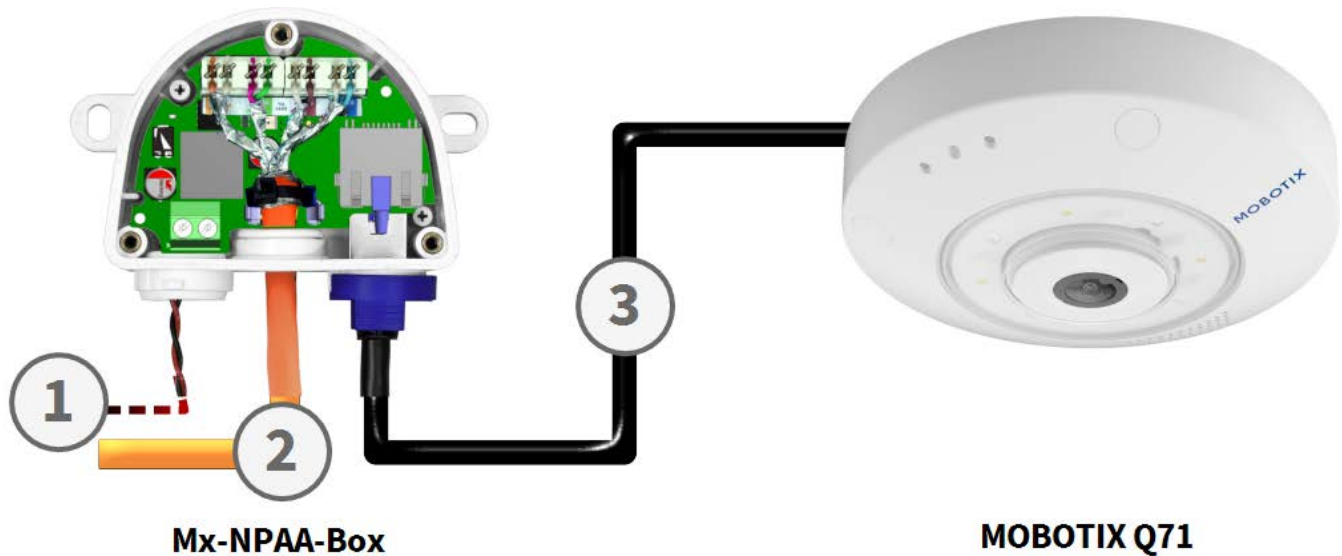

1. Power supply 12 to 24 V DC (power supply unit or battery with fuse 3 A).
2. Ethernet installation cable to router.
3. MOBOTIX patch cable to camera.

**NOTE!** Only use MOBOTIX patch cables with integrated sealing ring!

## Attach the box

Attach the Mx-NPAA-Box at the mounting position with the cable ports pointing downwards (max. torque 0.4 Nm). Next, remove the box cover (three screws).

**NOTE!** If you need a drilling template, please see [Dimensions/Drilling Template, p. 8.](#)

## Set up the connections

### 1. Insert the cable tie

Feed the supplied cable tie through the two slots on the circuit board.



### 2. Prepare the installation cable

- Cut the installation cable to size.
- Push the installation cable through the suitable cable plug (5 to 7 mm).
- Strip the cable for at least 35 mm and separate the individual wires of the cable into twisted pairs with 20 mm shielding.
- Wrap the shield mesh 10 mm wide around the cable so that it can rest on the contact plate of the board. The cable will be fastened with a cable tie later on.

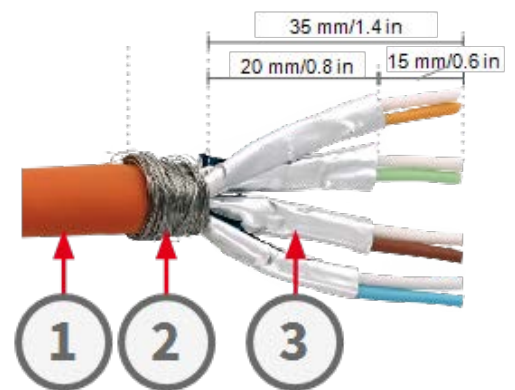

1. Installation cable
2. Shield mesh
3. Pair shields

### 3. Feed the cable into the box

- Replace the sealing plug in the middle of the Mx-NPAA-Box.
- Feed the installation cable through the opening and press the cable plug with the 5 to 7 mm opening into its seat. In order to prevent humidity entering the box, the rubber sleeve needs to be tight against the cable.
- Pull the cable tie tight around the cable shield to provide proper strain relief.



### 4. Connect the cable wires

Use an LSA PLUS wire tool to insert the individual wires into the LSA terminal. Decide on using either the EIA/TIA-568A or B wiring standard as in the rest of the building. The color code sticker on the inside of the box indicates both standards.



## Quick Installation

### MOBOTIX Mx-NPAA-Box

#### 5. Connect the power supply

- Guide the power supply cable through a suitable opening of the left rubber plug. Use the eight-wire plug for inserting single wires; use the appropriate cable plug 3 to 5 mm or 5 to 7 mm for inserting an insulated multi-wire cable.
- Strip 5 mm off of the insulation of the wires to the power supply unit or battery (12 to 24 V DC). Apply wire-end sleeves if using flexible wires.
- Attach to the power terminal according to polarity.

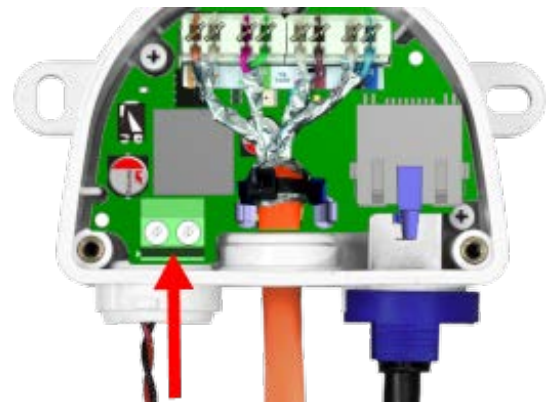

#### 6. Attach the patch cable

- Remove bayonet catch and the sealing plug of the right port.
- Insert a MOBOTIX patch cable into the right port and secure it using the bayonet catch.



**NOTE!** Only use MOBOTIX patch cables with integrated sealing ring!



## Mount the cover

Mount the cover back onto the Mx-NPAA-Box and attach it using the cover screws (torque 0.4 Nm).

For more information on the MX-Overvoltage-Protection-Box-LSA, please see [www.mobotix.com](http://www.mobotix.com) > [Support](#) > [Download Center](#) > [Marketing & Documentation](#) > [Manuals](#) and open the [Accessories](#) > [Interface Boxes](#) section.

# Additional Information

## LED Signals

Voltage (Input)	PoE Power (Output)	LED
12 V – 24 V	Class 1 to 4 (up to 25 W)	 

## Dimensions/Drilling Template

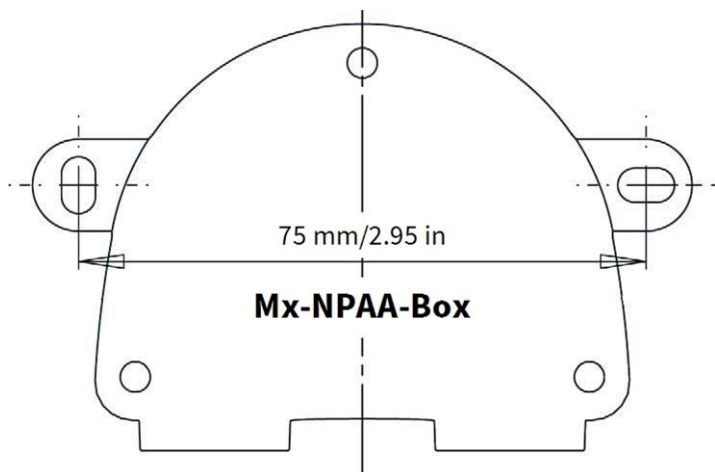

Fig. 1: Mx-NPAA-Box: All measurements in mm

**NOTE!** When printing this page at 100% of the original size (no scaling) you can use this page as drilling template.



# Technical Specifications

**Order Code:** Mx-F-NPAA

Protection Class IP66

Operating temperature -30 to 50 °C/-22 to 122 °F

Certificates CE, EMC, ROHS,  
AS/NZS CISPR 32,  
47 CFR FCC Part 15, Subpart B, Class A,  
ICES-003 Class A

Dimensions 86 x 56 x 31 mm/3.39 x 2.20 x 1.22 in  
(width x height x depth) (without rubber plugs)

Weight 70 g

---

# MOBOTIX

BeyondHumanVision

EN\_06/24

MOBOTIX AG • Kaiserstrasse • D-67722 Langmeil • Tel.: +49 6302 9816-103 • sales@mobotix.com • www.mobotix.com

MOBOTIX is a trademark of MOBOTIX AG registered in the European Union, the U.S.A., and in other countries. Subject to change without notice. MOBOTIX do not assume any liability for technical or editorial errors or omissions contained herein. All rights reserved. © MOBOTIX AG 2024