

Modbus MS Card

User manual

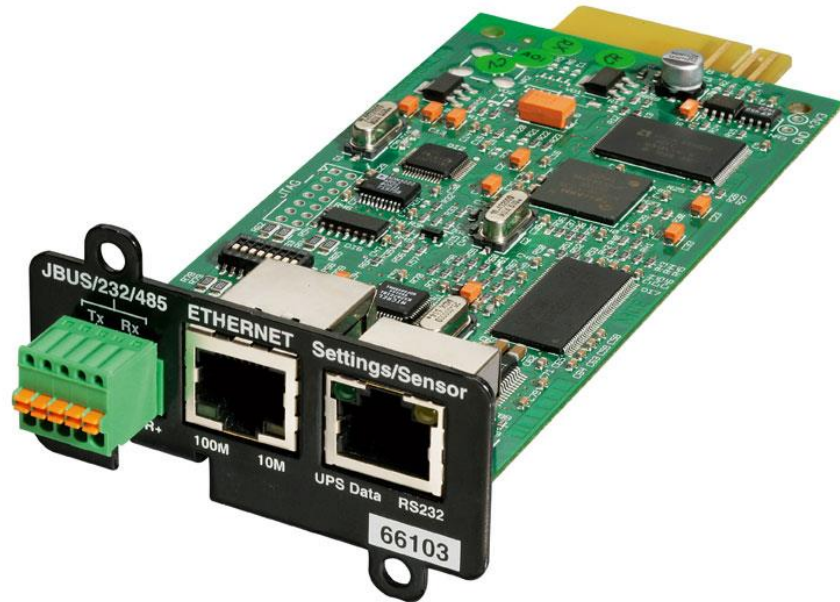

Contents

1	INTRODUCTION	4
2	PRESENTATION	5
2.1	OVERVIEW	5
2.2	FUNCTIONS	5
2.3	TECHNICAL CHARACTERISTICS	6
3	INSTALLATION	7
3.1	RS232 LINK CONFIGURATION AND CONNECTION	7
3.2	RS485 LINK CONFIGURATION AND CONNECTION	8
3.2.1	RS485 connection	8
3.2.2	RS485 link configuration for 2 wires connexion	10
3.2.3	RS485 link configuration for 4 wires connexion	12
3.3	CONFIGURATION OF THE JBUS/MODBUS COMMUNICATION PARAMETERS	14
3.3.1	Choice 1: Display Jbus settings	15
3.3.2	Choice 2: Modify Jbus settings	15
3.3.3	Choice 3: Display Jbus diagnostics	16
3.3.4	Choice 4: Reset Jbus diagnostics	16
3.3.5	Choice 5: Return to Jbus Default Configuration	16
3.3.6	Choice 6: Display Jbus frames	16
4	ADDITIONAL WEB PAGES	18
5	MENU/CLI INTERFACES	19
5.1	MENU INTERFACE	19
5.1.1	Main menu	19
5.1.2	Modbus/Jbus menu	19
5.2	COMMAND LINE INTERFACE	21
5.2.1	“getJBUS”	21
5.2.2	“setJBUS”	21
5.2.3	“getJBUSCounter”	22
5.2.4	“setJBUSCounter”	22
6	JBUS TABLE	23
6.1	DATA FOR PULSAR 700 / 1000 / 1500	23
6.1.1	Status table	23
6.1.2	Measurements table	24
6.2	DATA FOR PULSAR M 2200 / 3000	25
6.2.1	Status table	25
6.2.2	Measurements table	26
6.3	DATA FOR PULSAR MX 4000 / 5000 / 10000	27
6.3.1	Status table	27
6.3.2	Measurements table	28
6.4	DATA FOR PULSAR MX FRAME 15 / 20	29

6.4.1	Status table	29
6.4.2	Modular fault table	30
6.4.3	Measurements table	32
6.5	DATA FOR EATON 93E AND EATON 93PM	34
6.5.1	Status table	34
6.5.2	Measurements table	35
6.6	DATA FOR EATON 5PX AND EATON 5P	37
6.6.1	Status table	37
6.6.2	Measurements table	38
6.7	DATA FOR EATON 9E	39
6.7.1	Status table	39
6.7.2	Measurements table	40
6.8	DATA FOR EATON 9PX AND EATON 9SX SINGLE PHASE	41
6.8.1	Status table	41
6.8.2	Measurements table	42
6.9	DATA FOR EATON 9PX THREE PHASE INPUT	43
6.9.1	Status table	43
6.9.2	Measurements table	44
6.10	DATA FOR EATON 9PX SPLIT PHASE	45
6.10.1	Status table	45
6.10.2	Measurements table	46
6.11	GENERIC UPS	47
6.11.1	Status table	47
6.11.2	Measurements table	49
6.12	SENSOR DATA	51
6.12.1	Status table	51
6.12.2	Measurements table	52
6.12.3	Read of the personalization table	53
6.13	OTHER DATA	54
7	GLOSSARY	55

1 Introduction

The embedded application of the Modbus MS Card (previously INMC) is based on the Network MS Card (previously NMC).

For all common features, the user manual is the same as NMC (see reference below).

In this document, only JBUS/MODBUS requirements are described.

- Reference

Network Management Card – User Manual 34003990XT_FR/EF

2 Presentation

2.1 Overview

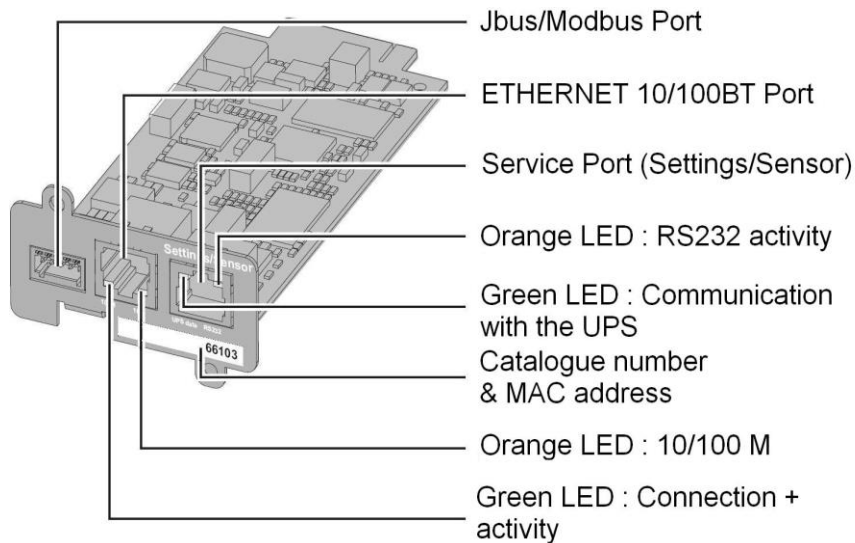

2.2 Functions

The **Modbus MS Card** provides the same functions than the Network MS card described in the previous section of this document.

The adding function consists to provide **UPS** (Uninterruptible Power Supply) data (states and measures) to be sent a computer system.

The **JBUS** hexadecimal (MODBUS RTU) communication protocol is used in slave mode. The system provides a communication channel with an RS485 or RS232 interface.

Note:

2 wires or 4 wires RS485 link are available.

Warning:

RS232 and RS485 communication ports cannot be used together.

JBUS/MODBUS communication is operational 2 minutes after the startup of the card.

2.3 Technical characteristics

Functions	Parameters	Default values	Possible values
JBUS/MODBUS communication	<ul style="list-style-type: none"> - Baud rate - Parity - Bit number - Stop bit - Slave number 	<ul style="list-style-type: none"> - 9600 bauds - without parity - 8 - 2 - Slave nr 1 	<ul style="list-style-type: none"> - 1200, 2400, 4800, 9600, 19200, 38400 - Without parity, even parity, odd parity - - 1, 2 - 1 to FF (hexadecimal)
RS232 link	<ul style="list-style-type: none"> - Link connection in transmit data (Tx) or receive data (Rx) 	<ul style="list-style-type: none"> - Rx on pin 1 - Tx on pin 3 	<ul style="list-style-type: none"> - Rx on pin 1 - Tx on pin 3
RS485 link	<ul style="list-style-type: none"> - Termination 	<ul style="list-style-type: none"> - No termination 	<ul style="list-style-type: none"> - With or without (2 or 4 wires)

3 Installation

3.1 RS232 link configuration and connection

Set the SA2 switches like below:

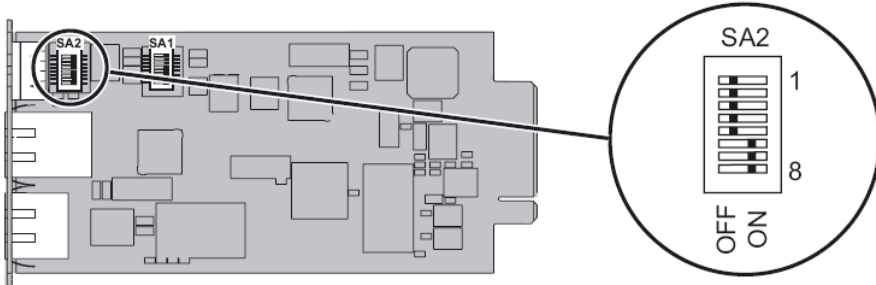

The next figure shows the details of the connection in RS232 mode:

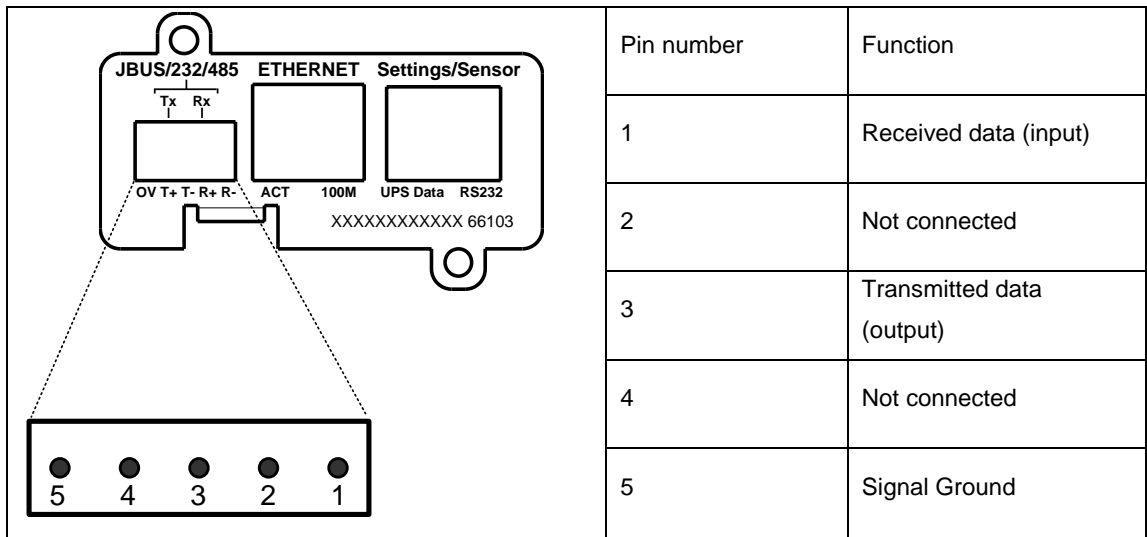

3.2 RS485 link configuration and connection

3.2.1 RS485 connection

Normally, the master of the network sets the polarity of the line. The Modbus MS card is a slave equipment and don't have polarisation resistor.

The two ends of the line must be terminated. Allow for 1 or 2 terminators to avoid mismatching the line when any equipment at the end of the line is disconnected.

The next figure gives the detail of the RS485 connector and the internals drivers:

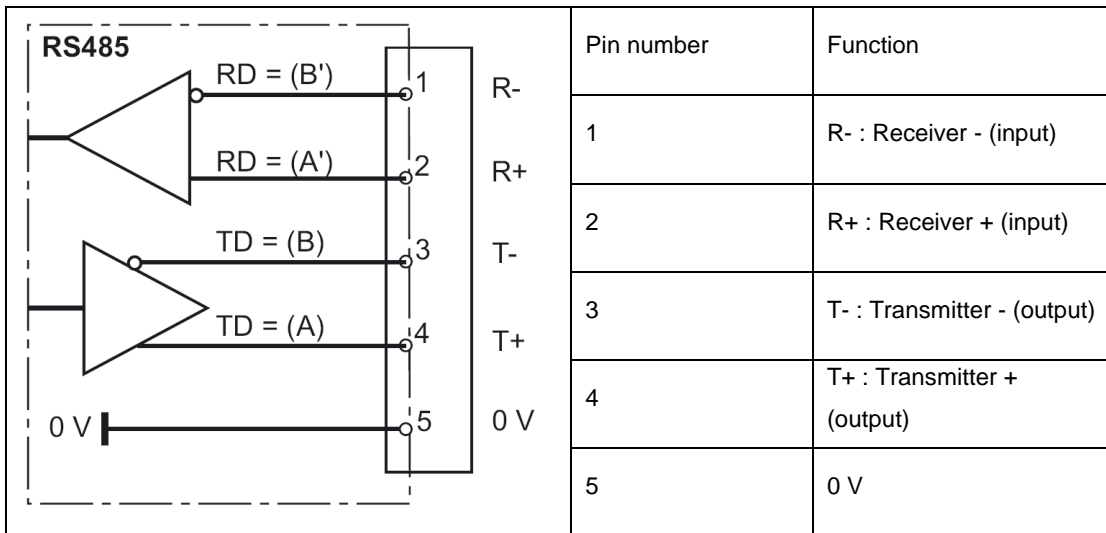

Important notes:

Use twisted pair cable (cable specification 0.3mm² and capacitance 42pF/m)

The transmission range will increase if a cable with lower capacitance and larger diameter is used.

Use shielded cable in heavy industrial environments.

The settings of the RS485 link are made through the SA1 switches:

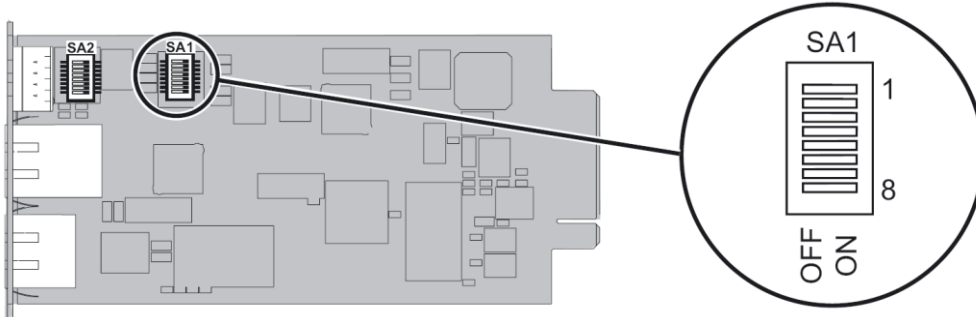

SA1 description:

- 1: reserved
- 2: reserved
- 3: link termination between T- to R- (2 wires configuration) if set to ON
- 4: connection T- to R- (2 wires configuration) if set to ON
- 5: connection T+ to R+ (2 wires configuration) if set to ON
- 6: reserved
- 7: reserved
- 8: link termination between R+ and R- if set to ON

3.2.2 RS485 link configuration for 2 wires connexion

Set the SA2 switches like below to set the RS485 mode:

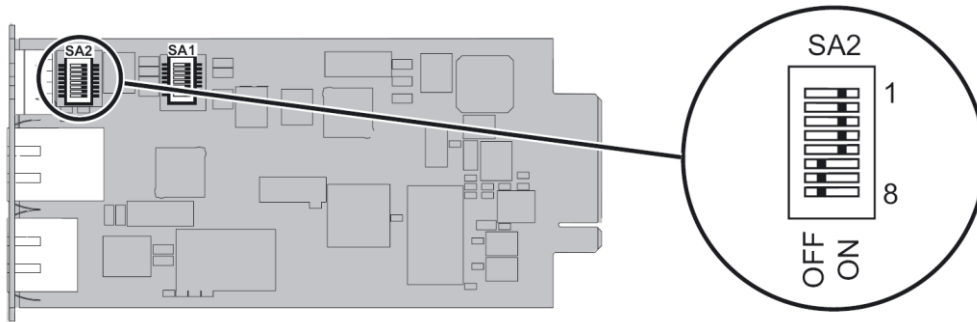

Set the SA1 switches to select the **two wires** configuration with **no termination**:

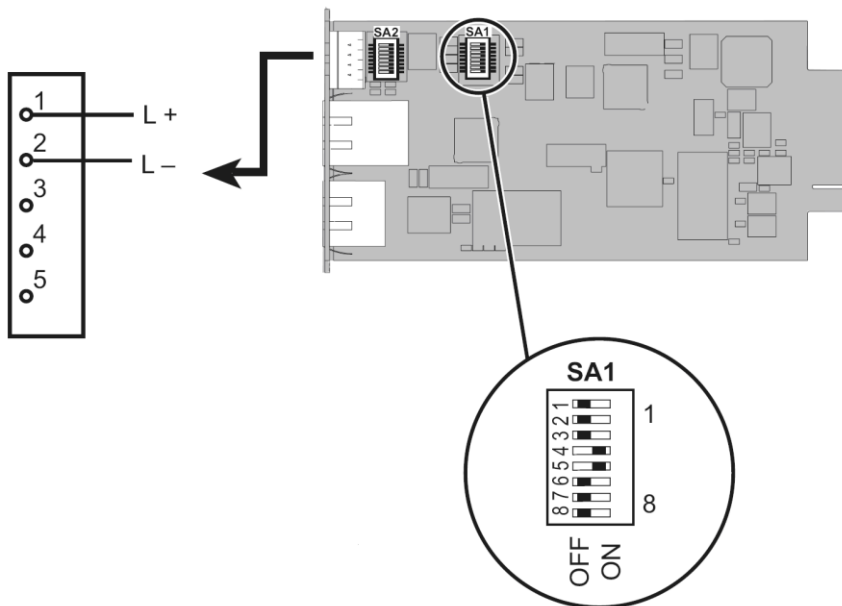

Set the SA1 switches to select the **two wires** configuration with **termination**:

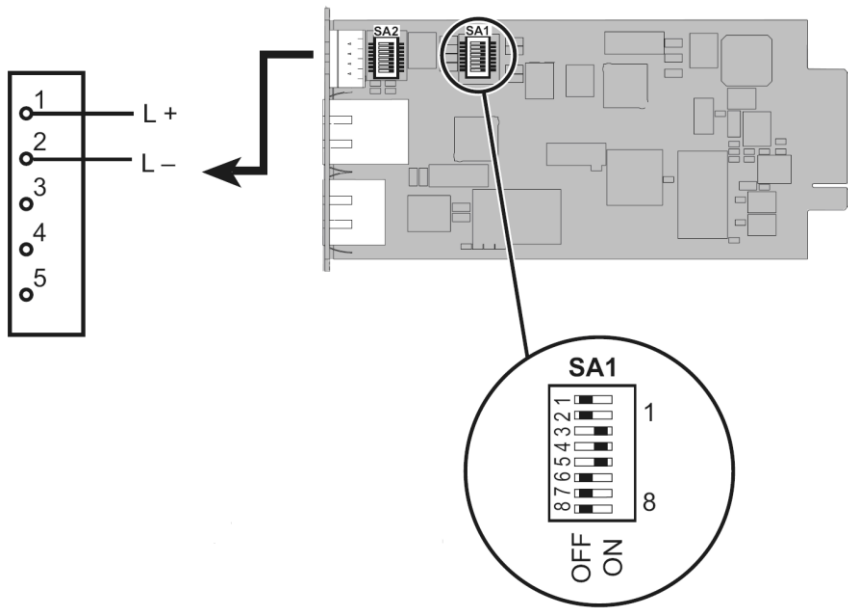

The next figure gives a typical bus structure in the two wires configuration:

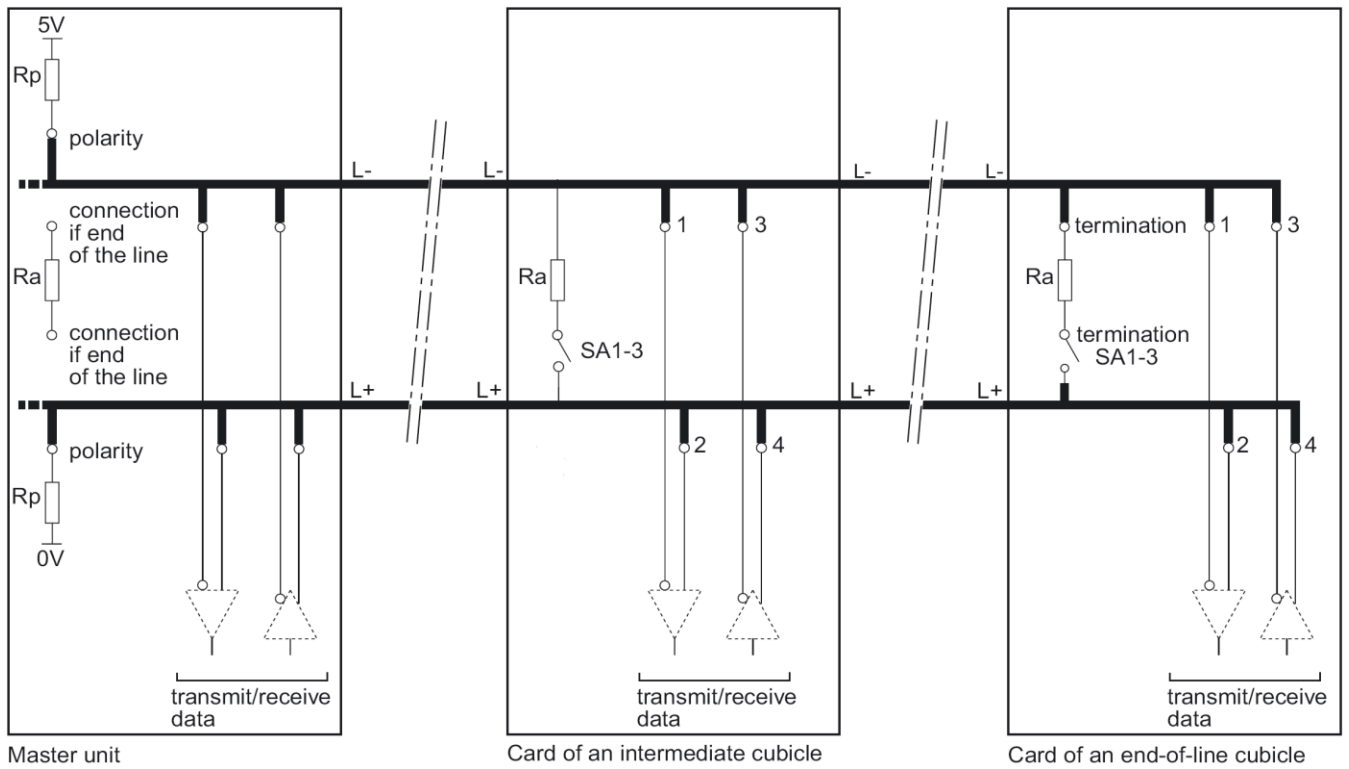

3.2.3 RS485 link configuration for 4 wires connexion

Set the SA2 switches like below:

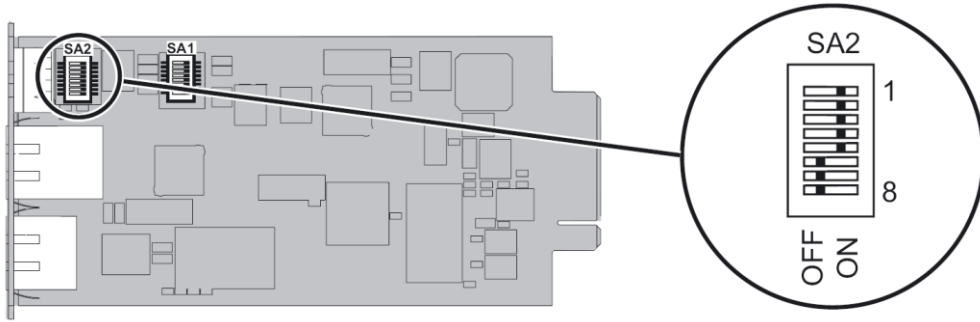

Set the SA1 switches to select the **four wires** configuration with **no termination**:

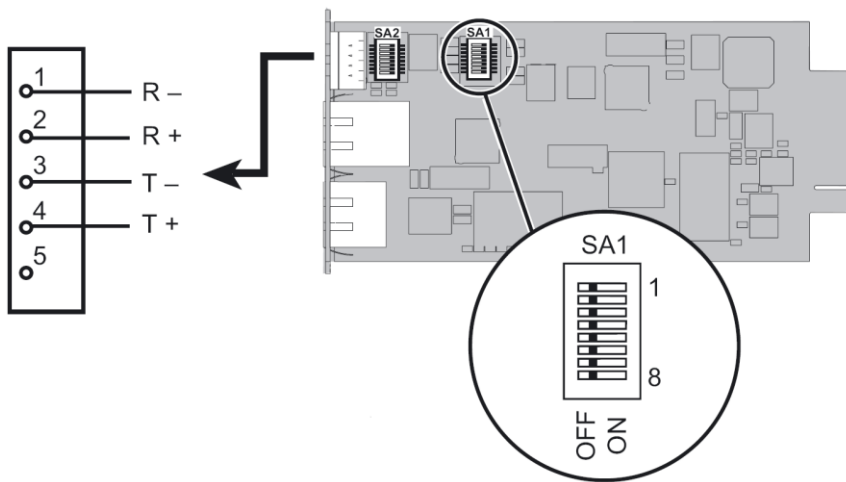

Set the SA1 switches to select the **four wires** configuration with **termination**:

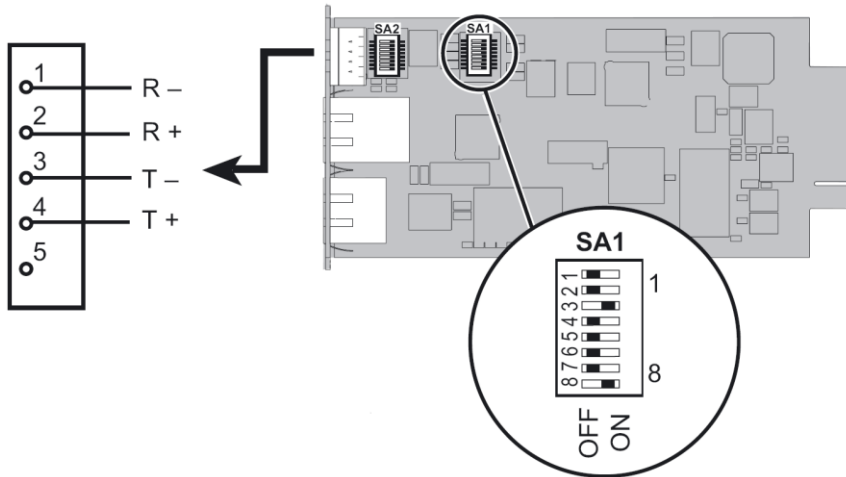

The next figure gives a typical bus structure in the four wires configuration:

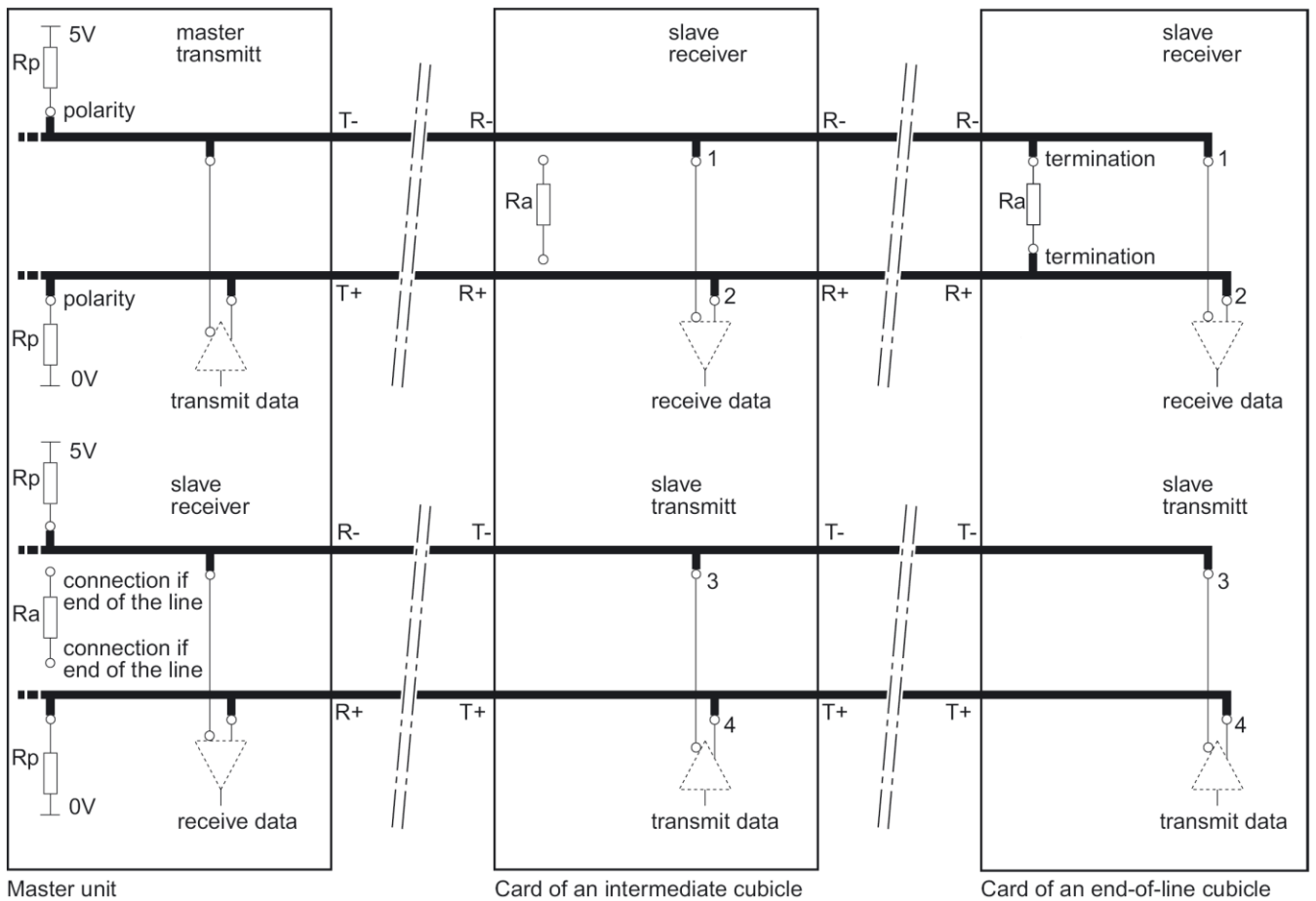

3.3 Configuration of the JBUS/MODBUS communication parameters

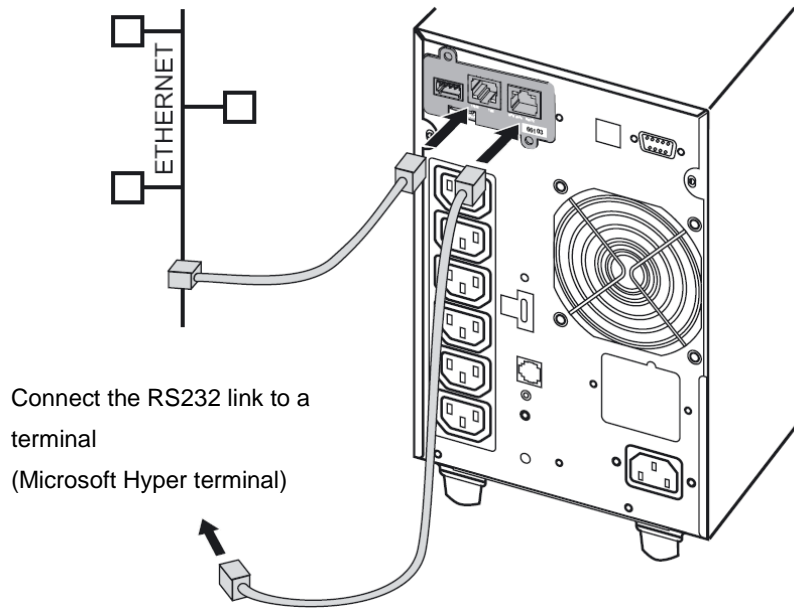

Use the cord supplied with the card.

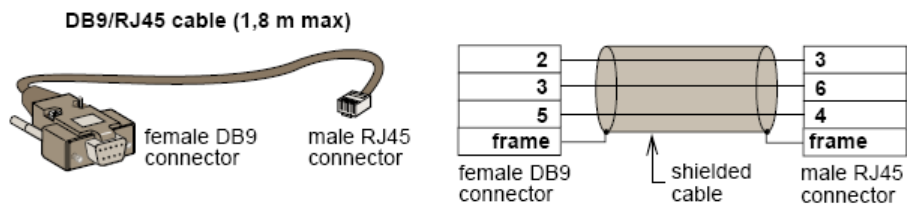

Connect the card to a computer equipped with a Hyper terminal type emulator. The serial link must be set at 9600 baud, 8 bits, no parity, 1 stop bit, and without flow control.

Check that UPS power is on.

Enter the **admin** password (not upgradable).

The next menu appears:

```
-----  
EATON NETWORK MANAGEMENT – JBUS CARD  
-----  
1 : Reset  
2 : Network configuration  
3 : Set Login Password to Default  
4 : Return to Default Configuration  
5 : Jbus configuration  
6 : Sensor configuration  
0 : Exit  
-----
```

Type 5 and return to display the JBUS configuration menu.

The next menu appears:

```
-----  
Jbus settings  
-----  
1 : Display Jbus settings  
2 : Modify Jbus settings  
3 : Display Jbus diagnostics  
4 : Reset Jbus diagnostics  
5 : Return to Jbus Default Configuration  
6 : Display Jbus frames  
0 : Exit  
-----
```

3.3.1 Choice 1: Display Jbus settings

Enables reading of the card's Jbus settings

```
Jbus configuration :  
Slave number : 1  
Speed : 9600 bds  
Data : 8 bits  
stop bit : 1  
Parity : None
```

3.3.2 Choice 2: Modify Jbus settings

Enable the modification of Jbus settings.

Setting Jbus configuration :
Set Slave number : 0x1
Set the Baud Rate [1: 38400, 2: 19200, 3: 9600, 4: 4800, 5: 2400, 6: 1200] :3

Set data format [1: 8 bits] :1

Set stop bit [1: 1 bits, 2: 2 bits] :1

Set Parity [1: None, 2: Even, 3: Odd] :1
Wait during the new configuration is saved ...
Slave JBUS initialized
The Jbus configuration is now updated.

3.3.3 Choice 3: Display Jbus diagnostics

Enable reading of the Jbus diagnostics.

Jbus diagnostics :
Cpt1 - Bus Message Count:0
Cpt2 - CRC Error Count :0
Cpt3 - Slave Exception Error Count:0
Cpt4 - Slave Message Count:0
Cpt5 - Slave No Response Count:0
Cpt6 - Slave NAK Count:0
Cpt7 - Slave Busy Count:0
Cpt8 - Bus Character Overrun Count:0
Cpt9 - Slave Correct Response Count:0

3.3.4 Choice 4: Reset Jbus diagnostics

Reset the Jbus diagnostic counters.

3.3.5 Choice 5: Return to Jbus Default Configuration

Returns to the Jbus default configuration (0x01, 9600, 8, 1, none)

Wait during Jbus configuration returns to default ...
Jbus Configuration has been set to default one.

3.3.6 Choice 6: Display Jbus frames

Enable the display of the Jbus frames:

Recv : 01 01 00 00 00 64 3d e1

Send : 01 81 02 c1 91

Recv : 01 03 00 62 00 64 e5 ff

Send : 01 03 c8 00 00 00 00 00 00 00 00 00 00 00 00 ...

Recv : 01 01 00 00 00 64 3d e1

Send : 01 81 02 c1 91

Recv : 01 03 00 62 00 64 e5 ff

Send : 01 03 c8 00 00 00 00 00 00 00 00 00 00 00 00 ...

4 Additional Web pages

The Modbus MS card parameters could be set through the next page:

EATON
Powering Business Worldwide

Network Management Card & ModBus/JBus

UPS

- UPS Properties
- UPS Control
- Weekly Schedule
- Shutdown Parameters

Logs and Notification

- Measurements
- Event Log
- System Log
- Email Notification

Settings

- Network
- System
- Notified Applications
- Access Control
- SNMP
- Time
- Firmware Upload

ModBus/JBus serial

- Settings

ModBus/JBus Settings **Help**

unknown **Computer Room**

Slave Number (Hex) :

Serial speed :

Data format :

Stop bit :

Parity :

Save modified settings :

5 Menu/CLI interfaces

The parameters links to JBUS communication are also accessible via Telnet, SSH or CLI interface.

Those parameters are:

Slave address

Bauds rate

Bit number

Stop bit

Parity

5.1 Menu interface

5.1.1 Main menu

This screen is the main screen displayed when the connection is established.

```
-----  
EATON NETWORK MANAGEMENT- JBUS CARD  
Main menu  
-----  
  1 : Reset  
  2 : Network settings  
  3 : Trap receivers  
  4 : System settings  
  5 : Shutdown settings  
  6 : Access control  
  7 : Date and Time  
  8 : Environment settings  
  9 : Modbus/Jbus settings  
 10 : Set login password to default  
 11 : Default configuration  
  
Quit : Close session  
-----
```

5.1.2 Modbus/Jbus menu

Theses menus are used to visualize or modify the Jbus network settings and to visualize the status of the communication.

EATON NETWORK MANAGEMENT - JBUS CARD

Modbus/Jbus settings

-
- 1 : Serial link
 - 2 : Diagnostic counters

 - 0 : Exit
-

EATON NETWORK MANAGEMENT - JBUS CARD

Modbus/Jbus settings – Serial link

-
- 1 : Slave address [1]
 - 2 : Baud rate (1200, 2400, 4800, 9600, 19200, 38400) [9600]
 - 3 : Data bits (8) [8]
 - 4 : Stop bits (1, 2) [1]
 - 5 : Parity (0=None, 1=Odd, 2=Even) [0]

 - 0 : Exit
-

EATON NETWORK MANAGEMENT - JBUS CARD

Modbus/Jbus settings – Serial link

-
- : Buss message [24]
 - : CRC error [0]
 - : Slave exception error [0]
 - : Slave message [24]
 - : Slave no response [0]
 - : Slave NAK [0]
 - : Slave busy [0]
 - : Bus character overrun [0]
 - : Slave correct response [0]
 - 10 : Reset diagnostic counter

 - 0 : Exit
-

All items (1 à 9) are read only.

5.2 Command Line Interface

Command Line Interface (CLI) API provides functions for building and processing a user-defined HMI. To use the CLI, the parameter "HMI type" has to be equal to "CLI".

When opening a new session, TELNET or SSH, a specific prompt "#>" is sent to the client. The user can enter a command. If the command is recognized, it is processed, else a warning message is sent to the client.

The syntax used is based on that already implemented for the XML description of objects. The blank character is not allowed in command arguments except for the strings. The strings are in double quotes ("").

The code colour is the following:

- Setting in read-write or write-only mode: light green
- Setting in read-only mode: yellow
- Warning message: green
- Error message: light red

The recognized commands are given in the following chapters and may be updated later.

5.2.1 "getJBUS"

Purpose	To read a JBUS network setting
Syntax	getJBUS [option1] [option2]... options : SlaveAddress Speed DataBit StopBit Parity
Examples	#> getJBUS Speed Parity

5.2.2 "setJBUS"

Purpose	To modify a JBUS network setting
Syntax	setJBUS [option1] [option2]... options : SlaveAddress = xxx (1..255) Speed = xxx (1200 2400 4800 9600 19200 38400) DataBit = x (8) StopBit = x (1 2) Parity = x (0=None, 1=Odd, 2=Even)
Examples	#> setJBUS Speed = 19200 Parity = 2

5.2.3 “getJBUSCounter”

Purpose	To read a JBUS diagnostic counters
Syntax	getJBUSCounter [option1] [option2]... options : BusMessage CRCErrror SlaveException SlaveMessage SlaveNoResponse SlaveNAK SlaveBusy Overrun SlaveCorrectResponse All
Examples	#> getJBUSCounter All

5.2.4 “setJBUSCounter”

Purpose	Reset of the JBUS diagnostics counters
Syntax	setJBUSCounter [option1] options : RAZ
Examples	#> setJBUSCounter RAZ

6 JBUS table

6.1 Data for Pulsar 700 / 1000 / 1500

6.1.1 Status table

<i>Status description</i>	<i>Status to 0</i>	<i>Status to 1</i>	<i>Word (hex)</i>	Bit
Load protected	no	yes	40	0
UPS coupled	no	yes	40	1
Unit general alarm	no	yes	40	2
UPS in backup	no	yes	40	4
Battery low warning	no	yes	40	5
Low battery	no	yes	40	6
Operation on static switch	no	yes	40	7
Communication fault	absent	present	40	9
UPS overload	no	yes	40	A
Emergency stop	absent	present	40	B
Battery to be checked	no	yes	40	D
Device ventilation fault	no	yes	40	E
Battery present	absent	present	42	0
Mains 1 voltage out of tolerance	no	yes	44	8
Mains 1 frequency out of tolerance	no	yes	44	B
Bypass status	no	yes	46	7
Charger general fault	no	yes	49	0
Battery charge	not in charge	in charge	49	1 & 3
Converter fault	no	yes	4A	1
Inverter fault	no	yes	4C	1

6.1.2 Measurements table

<i>Description of the physical quantity</i>	<i>Word (hex)</i>	Unit
I output	109	A
U output	124	V
U battery	12D	V
Output active power	136	W
Output apparent power	137	VA
% output load level	139	%
Power factor (Cos PHI)	13D	-
Mains 1 frequency	13E	Hz
Output frequency	141	Hz
Battery backup time	149	Min
Battery charging level	14B	%
U mains 1	150	V
Nominal voltage of battery element	213	V

6.2 Data for Pulsar M 2200 / 3000

6.2.1 Status table

<i>Status description</i>	<i>Status to 0</i>	<i>Status to 1</i>	<i>Word (hex)</i>	Bit
Load protected	no	yes	40	0
UPS coupled	no	yes	40	1
Unit general alarm	no	yes	40	2
UPS in backup	no	yes	40	4
Battery low warning	no	yes	40	5
Low battery	no	yes	40	6
Operation on static switch	no	yes	40	7
Communication fault	absent	present	40	9
UPS overload	no	yes	40	A
Emergency stop	absent	present	40	B
Battery to be checked	no	yes	40	D
Device ventilation fault	no	yes	40	E
Manual bypass switch (Q3BP)	open	closed	41	6
Battery present	absent	present	42	0
Mains 1 voltage out of tolerance	no	yes	44	8
Mains 1 frequency out of tolerance	no	yes	44	B
Redundancy lost	no	yes	45	7
Maintenance position	no	yes	46	1
Mains 2 overload	no	yes	46	5
Output on bypass	no	yes	46	7
Mains 2 frequency out of tolerance	no	yes	46	9
Mains 2 voltage out of tolerance	no	yes	46	A
Phase M2 out of tolerance	no	yes	46	B
Charger general fault	no	yes	49	0
Battery charge	no	yes	49	1 & 3
Converter fault	no	yes	4A	1
Inverter major fault	no	yes	4C	1

6.2.2 Measurements table

<i>Description of the physical quantity</i>	<i>Word (hex)</i>	<i>Unit</i>
I mains 2	106	A
I output	109	A
U mains 2	11E	V
U output	124	V
U battery	12D	V
Output active power	136	W
Output apparent power	137	VA
% output load level	139	%
Power factor x 100	13D	-
Mains 1 frequency	13E	dHz
Output frequency	141	dHz
Battery backup time	149	Min
Battery charging level	14B	%
U mains 1	150	V
Nominal voltage of battery element	213	V

6.3 Data for Pulsar MX 4000 / 5000 / 10000

6.3.1 Status table

<i>Status description</i>	<i>Status to 0</i>	<i>Status to 1</i>	<i>Word (hex)</i>	<i>Bit</i>
Load protected	no	yes	40	0
UPS coupled	no	yes	40	1
Unit general alarm	no	yes	40	2
UPS in backup	no	yes	40	4
Battery low warning	no	yes	40	5
Low battery	no	yes	40	6
Operation on static switch	no	yes	40	7
Communication fault	absent	present	40	9
UPS overload	no	yes	40	A
Emergency stop	absent	present	40	B
Battery to be checked	no	yes	40	D
Device ventilation fault	no	yes	40	E
Manual bypass switch (Q3BP)	open	closed	41	6
UPS in "eco" mode	no	yes	41	7
Battery present	absent	present	42	0
Mains 1 voltage out of tolerance	no	yes	44	8
Mains 1 fuse fault	no	yes	44	9
Mains 1 frequency out of tolerance	no	yes	44	B
Redundancy lost	no	yes	45	7
Maintenance position	no	yes	46	1
Mains 2 overload	no	yes	46	5
Mains 2 thermal overload	no	yes	46	6
Output on bypass	no	yes	46	7
Mains 2 frequency out of tolerance	no	yes	46	9
Mains 2 voltage out of tolerance	no	yes	46	A
Phase M2 out of tolerance	no	yes	46	B
Mains 2 internal fault	absent	present	47	2
Charger general fault	no	yes	49	0
Battery charge	no	yes	49	1 & 3
Converter fault	no	yes	4A	1
Inverter major fault	no	yes	4C	1
Inverter overload	no	yes	4C	2
Inverter thermal overload	no	yes	4C	3
Inverter limitation	no	yes	4C	4
UPS fuse fault	absent	present	4C	5

6.3.2 Measurements table

<i>Description of the physical quantity</i>	<i>Word (hex)</i>	Unit
I mains 1	100	A
I mains 2	106	A
I output	109	A
I battery	10E	A
U mains 2	11E	V
U output	124	V
U battery	12D	V
Output active power	136	W
Output apparent power	137	VA
% output load level	139	%
Power factor (Cos PHI)	13D	-
Mains 1 frequency	13E	dHz
Mains 2 frequency	140	dHz
Output frequency	141	dHz
Battery backup time	149	Min
Battery charging level	14B	%
U mains 1	150	V
Nominal voltage of battery element	213	V

6.4 Data for Pulsar MX frame 15 / 20

6.4.1 Status table

<i>Status description</i>	<i>Status to 0</i>	<i>Status to 1</i>	<i>Word (hex)</i>	<i>Bit</i>
Load protected	no	yes	40	0
UPS coupled	no	yes	40	1
Unit general alarm	no	yes	40	2
UPS in backup	no	yes	40	4
Battery low warning	no	yes	40	5
Low battery	no	yes	40	6
Operation on static switch	no	yes	40	7
Communication fault	absent	present	40	9
UPS overload	no	yes	40	A
Emergency stop	absent	present	40	B
Battery to be checked	no	yes	40	D
Device ventilation fault	no	yes	40	E
Manual bypass switch (Q3BP)	open	closed	41	6
Battery present	absent	present	42	0
Mains 1 voltage out of tolerance	no	yes	44	8
Mains 1 fuse fault	no	yes	44	9
Mains 1 frequency out of tolerance	no	yes	44	B
Redundancy lost	no	yes	45	7
Maintenance position	no	yes	46	1
Mains 2 overload	no	yes	46	5
Mains 2 thermal overload	no	yes	46	6
Output on bypass	no	yes	46	7
Mains 2 frequency out of tolerance	no	yes	46	9
Mains 2 voltage out of tolerance	no	yes	46	A
Phase M2 out of tolerance	no	yes	46	B
Mains 2 internal fault	absent	present	47	2
Charger general fault	no	yes	49	0
Battery charge	no	yes	49	1 & 3
Inverter major fault	no	yes	4C	1
Inverter overload	no	yes	4C	2
Inverter thermal overload	no	yes	4C	3
Inverter limitation	no	yes	4C	4
UPS fuse fault	absent	present	4C	5

6.4.2 Modular fault table

<i>Description du Status</i>		<i>Status to 0</i>	<i>Status to 1</i>	<i>Word (hex)</i>	<i>Bit</i>
Module 1	General alarm	Absent	Present	61	0
	Fan failure	Absent	Present	61	1
	Internal communication fault	Absent	Present	61	2
	Inverter thermal overload	Absent	Present	61	3
	Inverter fault	Absent	Present	61	4
	Inverter fuse blown	Absent	Present	61	5
	Load short circuit	Absent	Present	61	6
Module 2	General alarm	Absent	Present	62	0
	Fan failure	Absent	Present	62	1
	Internal communication fault	Absent	Present	62	2
	Inverter thermal overload	Absent	Present	62	3
	Inverter fault	Absent	Present	62	4
	Inverter fuse blown	Absent	Present	62	5
	Load short circuit	Absent	Present	62	6
Module 3	General alarm	Absent	Present	63	0
	Fan failure	Absent	Present	63	1
	Internal communication fault	Absent	Present	63	2
	Inverter thermal overload	Absent	Present	63	3
	Inverter fault	Absent	Present	63	4
	Inverter fuse blown	Absent	Present	63	5
	Load short circuit	Absent	Present	63	6
Module 4	General alarm	Absent	Present	64	0
	Fan failure	Absent	Present	64	1
	Internal communication fault	Absent	Present	64	2
	Inverter thermal overload	Absent	Present	64	3
	Inverter fault	Absent	Present	64	4
	Inverter fuse blown	Absent	Present	64	5
	Load short circuit	Absent	Present	64	6

<i>Description du Status</i>		<i>Status to 0</i>	<i>Status to 1</i>	<i>Word (hex)</i>	<i>Bit</i>
Module 5	General alarm	Absent	Present	65	0
	Fan failure	Absent	Present	65	1
	Internal communication fault	Absent	Present	65	2
	Inverter thermal overload	Absent	Present	65	3
	Inverter fault	Absent	Present	65	4
	Inverter fuse blown	Absent	Present	65	5
	Load short circuit	Absent	Present	65	6
Module 6	General alarm	Absent	Present	66	0
	Fan failure	Absent	Present	66	1
	Internal communication fault	Absent	Present	66	2
	Inverter thermal overload	Absent	Present	66	3
	Inverter fault	Absent	Present	66	4
	Inverter fuse blown	Absent	Present	66	5
	Load short circuit	Absent	Present	66	6
Module 7	General alarm	Absent	Present	67	0
	Fan failure	Absent	Present	67	1
	Internal communication fault	Absent	Present	67	2
	Inverter thermal overload	Absent	Present	67	3
	Inverter fault	Absent	Present	67	4
	Inverter fuse blown	Absent	Present	67	5
	Load short circuit	Absent	Present	67	6
Module 8	General alarm	Absent	Present	68	0
	Fan failure	Absent	Present	68	1
	Internal communication fault	Absent	Present	68	2
	Inverter thermal overload	Absent	Present	68	3
	Inverter fault	Absent	Present	68	4
	Inverter fuse blown	Absent	Present	68	5
	Load short circuit	Absent	Present	68	6

6.4.3 Measurements table

<i>Description of the physical quantity</i>	<i>Word (hex)</i>	<i>Unit</i>
I1 (I phase 1) mains 1	100	A
I2 (I phase 2) mains 1	101	A
I3 (I phase 3) mains 1	102	A
I1 (I phase 1) mains 2	106	A
I2 (I phase 2) mains 2	107	A
I3 (I phase 3) mains 2	108	A
I1 (I phase 1) output	109	A
I2 (I phase 2) output	10A	A
I3 (I phase 3) output	10B	A
I battery	10E	A
U12 mains 1	115	V
U23 mains 1	116	V
U31 mains 1	117	V
U mains 2 (phase 1)	11E	V
U mains 2 (phase 2)	11F	V
U mains 2 (phase 3)	120	V
U12 mains 2	121	V
U23 mains 2	122	V
U31 mains 2	123	V
U1N output	124	V
U2N output	125	V
U3N output	126	V
U12 output	127	V
U23 output	128	V
U31 output	129	V
U battery	12D	V
Output active power (phase 1)	130	W
Output active power (phase 2)	131	W
Output active power (phase 3)	132	W
Output apparent power (phase 1)	133	VA
Output apparent power (phase 2)	134	VA
Output apparent power (phase 3)	135	VA
Output total active power	136	W
Output total apparent power	137	VA
% output load level	139	%
Peak factor phase 1 x 100	13A	-
Peak factor phase 2 x 100	13B	-
Peak factor phase 3 x 100	13C	-
Power factor x 100	13D	-
Mains 1 frequency	13E	dHz
Mains 2 frequency	140	dHz

<i>Description of the physical quantity</i>	<i>Word (hex)</i>	Unit
Output frequency	141	dHz
Battery backup time	149	Min
Battery charging level	14B	%
U mains 1 (phase 1)	150	V
U mains 1 (phase 2)	151	V
U mains 1 (phase 3)	152	V
Nominal voltage of battery element	213	V

6.5 Data for Eaton 93E and Eaton 93PM

6.5.1 Status table

<i>Status description</i>	<i>Status to 0</i>	<i>Status to 1</i>	<i>Word (hex)</i>	<i>Bit</i>
Load protected	no	yes	40	0
UPS coupled	no	yes	40	1
Unit general alarm	no	yes	40	2
UPS in backup	no	yes	40	4
Battery low warning	no	yes	40	5
Low battery	no	yes	40	6
Operation on static switch	no	yes	40	7
Communication fault	absent	present	40	9
UPS overload	no	yes	40	A
Emergency stop	absent	present	40	B
Battery to be checked	no	yes	40	D
Device ventilation fault	no	yes	40	E
Classe d'UPS	001 : off line / line interactive		41	1 to 3
	011 : on line - unitary/parallel			
	100 : on line – parallel with NS			
	101 : on line – hot standby redundancy			
Manual bypass switch (Q3BP)	open	closed	41	6
Mode ECO = 1	no	yes	41	7
Battery present	absent	present	42	0
Fuse fault	absent	present	42	B
Over temperature	absent	present	42	A & D
Circuit breaker QF1 status	open	close	42	F
Wiring fault	absent	present	44	2
Circuit breaker Q1 status	open	close	44	3
Mains 1 voltage out of tolerance	no	yes	44	8
Mains 1 fuse fault	no	yes	44	9
Mains 1 frequency out of tolerance	no	yes	44	B
Maintenance position	no	yes	46	1
Mains 2 overload	no	yes	46	5
Mains 2 thermal overload	no	yes	46	6
Output on bypass	no	yes	46	7
Mains 2 frequency out of tolerance	no	yes	46	9
Mains 2 voltage out of tolerance	no	yes	46	A
Phase M2 out of tolerance	no	yes	46	B
Circuit breaker Q4S status	open	close	46	E
Internal fault	absent	present	47	0
Mains 2 internal fault	absent	present	47	2

<i>Status description</i>	<i>Status to 0</i>	<i>Status to 1</i>	<i>Word (hex)</i>	<i>Bit</i>
Battery charge	no	yes	49	1 & 3
Chopper fault	absent	present	4A	1
Inverter major fault	no	yes	4C	1
Inverter overload	no	yes	4C	2
Inverter thermal overload	no	yes	4C	3
Inverter limitation	no	yes	4C	4
UPS fuse fault	absent	present	4C	5
Output voltage too high	no	yes	50	1
Output voltage too high	no	yes	50	2
Input voltage of bypass too high	no	yes	50	3
Input voltage of bypass too high	no	yes	50	4
Output frequency out of range	no	yes	50	5
Failure of the supply of electronic control	absent	present	50	6
Wiring fault of bypass	absent	present	50	7
Shutdown in progress	absent	present	50	8
Compatibility fault of the embedded software	absent	present	50	9
Rectifier status	absent	present	50	A

6.5.2 Measurements table

<i>Description of the physical quantity</i>	<i>Word (hex)</i>	<i>Unit</i>
I1 (I phase 1) mains 1	100	A
I2 (I phase 2) mains 1	101	A
I3 (I phase 3) mains 1	102	A
I1 (I phase 1) mains 2	106	A
I2 (I phase 2) mains 2	107	A
I3 (I phase 3) mains 2	108	A
I1 (I phase 1) output	109	A
I2 (I phase 2) output	10A	A
I3 (I phase 3) output	10B	A
I battery	10E	A
Nominal value active power	111	W of KW
U12 mains 1	115	V
U23 mains 1	116	V
U31 mains 1	117	V
U mains 2 (phase 1)	11E	V
U mains 2 (phase 2)	11F	V
U mains 2 (phase 3)	120	V
U12 mains 2	121	V
U23 mains 2	122	V

<i>Description of the physical quantity</i>	<i>Word (hex)</i>	Unit
U31 mains 2	123	V
U1N output	124	V
U2N output	125	V
U3N output	126	V
U12 output	127	V
U23 output	128	V
U31 output	129	V
U battery	12D	V
Output active power (phase 1)	130	W
Output active power (phase 2)	131	W
Output active power (phase 3)	132	W
Output apparent power (phase 1)	133	VA
Output apparent power (phase 2)	134	VA
Output apparent power (phase 3)	135	VA
Output total active power	136	W
Output total apparent power	137	VA
% output load level	139	%
Power factor x 100	13D	-
Mains 1 frequency	13E	Hz
Mains 2 frequency	140	Hz
Output frequency	141	Hz
Battery backup time	149	Min
U mains 1 (phase 1)	150	V
U mains 1 (phase 2)	151	V
U mains 1 (phase 3)	152	V
Nominal value apparent power	209	VA or KVA
Nominal voltage of battery element	213	V

6.6 Data for Eaton 5PX and Eaton 5P

6.6.1 Status table

<i>Status description</i>	<i>Status to 0</i>	<i>Status to 1</i>	<i>Word (hex)</i>	Bit
Load protected	no	yes	40	0
UPS coupled	no	yes	40	1
Unit general alarm	no	yes	40	2
UPS in backup	no	yes	40	4
Battery low warning	no	yes	40	5
Low battery	no	yes	40	6
Communication fault	absent	present	40	9
UPS overload	no	yes	40	A
Emergency stop	absent	present	40	B
Battery to be checked	no	yes	40	D
Device ventilation fault	no	yes	40	E
UPS Class	001 : off line / line interactive		41	1 to 3
	011 : on line - unitary/parallel			
	100 : on line – parallel with NS			
	101 : on line – hot standby redundancy			
Battery present	absent	present	42	0
Mode buck	no	yes	44	0
Mode Boost	no	yes	44	1
Mains 1 voltage out of tolerance	no	yes	44	8
Mains 1 frequency out of tolerance	no	yes	44	B
Charger general fault	no	yes	49	0
Battery charge	no	yes	49	1 & 3
Short circuit	no	yes	4F	1

6.6.2 Measurements table

<i>Description of the physical quantity</i>	<i>Word (hex)</i>	Unit
I Mains 1	100	A
I output	109	A
Nominal value active power	111	W of KW
U output	124	V
U battery	12D	V
Output active power	136	W
Output apparent power	137	VA
% output load level	139	%
Power factor (Cos PHI)	13D	-
Mains 1 frequency	13E	Hz
Output frequency	141	Hz
Battery backup time	149	Min
Battery charging level	14B	%
U mains 1	150	V
Nominal value apparent power	209	VA or KVA
Nominal voltage of battery element	213	V

6.7 Data for Eaton 9E

6.7.1 Status table

<i>Status description</i>	<i>Status to 0</i>	<i>Status to 1</i>	<i>Word (hex)</i>	<i>Bit</i>
Load protected	no	yes	40	0
UPS coupled	no	yes	40	1
Unit general alarm	no	yes	40	2
UPS in backup	no	yes	40	4
Battery low warning	no	yes	40	5
Low battery	no	yes	40	6
Operation on static switch	no	yes	40	7
Communication fault	absent	present	40	9
UPS overload	no	yes	40	A
Emergency stop	absent	present	40	B
Battery to be checked	no	yes	40	D
Device ventilation fault	no	yes	40	E
Classe d'UPS	001 : off line / line interactive 011 : on line - unitary/parallel 100 : on line – parallel with NS 101 : on line – hot standby redundancy		41	1 to 3
Manual bypass switch (Q3BP)	open	closed	41	6
Mode ECO = 1	no	yes	41	7
Battery present	absent	present	42	0
Wiring fault	absent	present	44	2
Mains 1 voltage out of tolerance	no	yes	44	8
Mains 1 frequency out of tolerance	no	yes	44	B
Maintenance position	no	yes	46	1
Output on bypass	no	yes	46	7
Mains 2 voltage out of tolerance	no	yes	46	A
Mains 2 internal fault	absent	present	47	2
Charger general fault	no	yes	49	0
Battery charge	no	yes	49	1 & 3
Inverter major fault	no	yes	4C	1
Inverter overload	no	yes	4C	2
Short circuit	no	yes	4F	1

6.7.2 Measurements table

<i>Description of the physical quantity</i>	<i>Word (hex)</i>	Unit
I output	109	A
Nominal value active power	111	W of KW
U mains 2	11E	V
U output	124	V
U battery	12D	V
Output total active power	136	W
Output total apparent power	137	VA
% output load level	139	%
Mains 1 frequency	13E	Hz
Mains 2 frequency	140	Hz
Output frequency	141	Hz
Battery backup time	149	Min
Battery charging level	14B	%
U mains 1 (phase 1)	150	V
U mains 1 (phase 2)	151	V
U mains 1 (phase 3)	152	V
Nominal value apparent power	209	VA or KVA
Nominal voltage of battery element	213	V

6.8 Data for Eaton 9PX and Eaton 9SX Single phase

6.8.1 Status table

Status description	Status to 0	Status to 1	Word (hex)	Bit
Load protected	no	yes	40	0
UPS coupled	no	yes	40	1
Unit general alarm	no	yes	40	2
Configuration firmware fault	no	yes	40	3
UPS in backup	no	yes	40	4
Battery low warning	no	yes	40	5
Low battery	no	yes	40	6
Operation on static switch	no	yes	40	7
Communication fault	absent	present	40	9
UPS overload	no	yes	40	A
Emergency stop	absent	present	40	B
Battery to be checked	no	yes	40	D
Device ventilation fault	no	yes	40	E
Classe d'UPS	001 : off line / line interactive 011 : on line - unitary/parallel 100 : on line – parallel with NS 101 : on line – hot standby redundancy		41	1 to 3
Manual bypass present	absent	present	41	5
Manual bypass switch (Q3BP)	open	closed	41	6
Mode ECO = 1	no	yes	41	7
Battery present	absent	present	42	0
Battery test	no	yes	42	2
Fuse fault	absent	present	42	B
Timer expired	absent	present	43	3
Wiring fault	absent	present	44	2
Mains 1 voltage out of tolerance	no	yes	44	8
Mains 1 frequency out of tolerance	no	yes	44	B
Redundancy lost	no	yes	45	7
Maintenance position	no	yes	46	1
Mains 2 overload	no	yes	46	5
Output on bypass	no	yes	46	7
Mains 2 frequency out of tolerance	no	yes	46	9
Mains 2 voltage out of tolerance	no	yes	46	A
Charger general fault	no	yes	49	0
Battery charge	no	yes	49	1 & 3
Chopper fault	absent	present	4A	1
Rectifier short circuit	absent	present	4A	2

<i>Status description</i>	<i>Status to 0</i>	<i>Status to 1</i>	<i>Word (hex)</i>	<i>Bit</i>
Inverter major fault	no	yes	4C	1
Inverter overload	no	yes	4C	2
Short circuit	no	yes	4F	1
Output frequency out of range	no	yes	50	5
Electronic power supply fault	no	yes	50	6

6.8.2 Measurements table

<i>Description of the physical quantity</i>	<i>Word (hex)</i>	<i>Unit</i>
I mains 2	106	A
I output	109	A
I battery	10E	A
Nominal value active power	111	W of KW
U mains 2	11E	V
U output	124	V
U battery	12D	V
Output total active power	136	W
Output total apparent power	137	VA
% output load level	139	%
Power factor x 100	13D	-
Mains 1 frequency	13E	Hz
Mains 2 frequency	140	Hz
Output frequency	141	Hz
Battery backup time	149	Min
Battery charging level	14B	%
U mains 1	150	V
Nominal value apparent power	209	VA or KVA
Nominal voltage of battery element	213	V

6.9 Data for Eaton 9PX Three phase Input

6.9.1 Status table

Status description	Status to 0	Status to 1	Word (hex)	Bit
Load protected	no	yes	40	0
UPS coupled	no	yes	40	1
Unit general alarm	no	yes	40	2
Configuration firmware fault	no	yes	40	3
UPS in backup	no	yes	40	4
Battery low warning	no	yes	40	5
Low battery	no	yes	40	6
Operation on static switch	no	yes	40	7
Communication fault	absent	present	40	9
UPS overload	no	yes	40	A
Emergency stop	absent	present	40	B
Battery to be checked	no	yes	40	D
Device ventilation fault	no	yes	40	E
Classe d'UPS	001 : off line / line interactive 011 : on line - unitary/parallel 100 : on line – parallel with NS 101 : on line – hot standby redundancy		41	1 to 3
Manual bypass present	absent	present	41	5
Manual bypass switch (Q3BP)	open	closed	41	6
Mode ECO = 1	no	yes	41	7
Battery present	absent	present	42	0
Battery test	no	yes	42	2
Fuse fault	absent	present	42	B
Timer expired	absent	present	43	3
Wiring fault	absent	present	44	2
Mains 1 voltage out of tolerance	no	yes	44	8
Mains 1 fuse fault	no	yes	44	9
Mains 1 frequency out of tolerance	no	yes	44	B
Redundancy lost	no	yes	45	7
Maintenance position	no	yes	46	1
Mains 2 overload	no	yes	46	5
Output on bypass	no	yes	46	7
Mains 2 frequency out of tolerance	no	yes	46	9
Mains 2 voltage out of tolerance	no	yes	46	A
Charger general fault	no	yes	49	0
Battery charge	no	yes	49	1 & 3
Chopper fault	absent	present	4A	1

<i>Status description</i>	<i>Status to 0</i>	<i>Status to 1</i>	<i>Word (hex)</i>	Bit
Rectifier short circuit	absent	present	4A	2
Inverter major fault	no	yes	4C	1
Inverter overload	no	yes	4C	2
Inverter limitation	no	yes	4C	4
Short circuit	no	yes	4F	1

6.9.2 Measurements table

<i>Description of the physical quantity</i>	<i>Word (hex)</i>	Unit
I1 (I phase 1) mains 1	100	A
I2 (I phase 2) mains 1	101	A
I3 (I phase 3) mains 1	102	A
I mains 2	106	A
I output	109	A
I battery	10E	A
Nominal value active power	111	W of KW
U mains 2 (phase 1)	11E	V
U output	124	V
U battery	12D	V
Output total active power	136	W
Output total apparent power	137	VA
% output load level	139	%
Power factor x 100	13D	-
Mains 1 frequency	13E	Hz
Mains 2 frequency	140	Hz
Output frequency	141	Hz
Battery backup time	149	Min
Battery charging level	14B	%
U mains 1 (phase 1)	150	V
U mains 1 (phase 2)	151	V
U mains 1 (phase 3)	152	V
Nominal value apparent power	209	VA or KVA
Nominal voltage of battery element	213	V

6.10 Data for Eaton 9PX Split phase

6.10.1 Status table

<i>Status description</i>	<i>Status to 0</i>	<i>Status to 1</i>	<i>Word (hex)</i>	<i>Bit</i>
Load protected	no	yes	40	0
UPS coupled	no	yes	40	1
Unit general alarm	no	yes	40	2
Configuration firmware fault	no	yes	40	3
UPS in backup	no	yes	40	4
Battery low warning	no	yes	40	5
Low battery	no	yes	40	6
Operation on static switch	no	yes	40	7
Communication fault	absent	present	40	9
UPS overload	no	yes	40	A
Emergency stop	absent	present	40	B
Battery to be checked	no	yes	40	D
Device ventilation fault	no	yes	40	E
Classe d'UPS	001 : off line / line interactive		41	1 to 3
	011 : on line - unitary/parallel			
	100 : on line – parallel with NS			
	101 : on line – hot standby redundancy			
Mode ECO = 1	no	yes	41	7
Battery present	absent	present	42	0
Battery test	no	yes	42	2
Fuse fault	absent	present	42	B
Timer expired	absent	present	43	3
Mains 1 voltage out of tolerance	no	yes	44	8
Mains 1 fuse fault	no	yes	44	9
Mains 1 frequency out of tolerance	no	yes	44	B
Mains 2 overload	no	yes	46	5
Mains 2 thermal overload	no	yes	46	6
Output on bypass	no	yes	46	7
Mains 2 frequency out of tolerance	no	yes	46	9
Mains 2 voltage out of tolerance	no	yes	46	A
Charger general fault	no	yes	49	0
Battery charge	no	yes	49	1 & 3
Chopper fault	absent	present	4A	1
Rectifier short circuit	absent	present	4A	2
Inverter major fault	no	yes	4C	1
Inverter overload	no	yes	4C	2

<i>Status description</i>	<i>Status to 0</i>	<i>Status to 1</i>	<i>Word (hex)</i>	<i>Bit</i>
Inverter thermal overload	no	yes	4C	3
Inverter limitation	no	yes	4C	4
Short circuit	no	yes	4F	1
Electronic power supply fault	no	yes	50	6

6.10.2 Measurements table

<i>Description of the physical quantity</i>	<i>Word (hex)</i>	<i>Unit</i>
I mains 2	106	A
I1 (I phase 1) output	109	A
I2 (I phase 2) output	10A	A
I battery	10E	A
Nominal value active power	111	W of KW
U12 mains 1	115	V
U mains 2 (phase 1)	11E	V
U mains 2 (phase 2)	11F	V
U12 mains 2	121	V
U1N output	124	V
U2N output	125	V
U12 output	127	V
U battery	12D	V
Output active power (phase 1)	130	W
Output active power (phase 2)	131	W
Output apparent power (phase 1)	133	VA
Output apparent power (phase 2)	134	VA
Output total active power	136	W
Output total apparent power	137	VA
% output load level	139	%
Mains 1 frequency	13E	Hz
Mains 2 frequency	140	Hz
Output frequency	141	Hz
Battery backup time	149	Min
Battery charging level	14B	%
U mains 1 (phase 1)	150	V
U mains 1 (phase 2)	151	V
Nominal value apparent power	209	VA or KVA
Nominal voltage of battery element	213	V

6.11 Generic UPS

6.11.1 Status table

<i>Status description</i>	<i>Status to 0</i>	<i>Status to 1</i>	<i>Word (hex)</i>	<i>Bit</i>
Load protected	No	yes	40	0
UPS coupled	No	yes	40	1
Unit general alarm	No	yes	40	2
Configuration firmware fault	no	yes	40	3
UPS in backup	No	yes	40	4
Battery low warning	No	yes	40	5
Low battery	No	yes	40	6
Operation on static switch	No	yes	40	7
Communication fault	Absent	present	40	9
UPS overload	No	yes	40	A
Emergency stop	Absent	present	40	B
Battery to be checked	No	yes	40	D
Device ventilation fault	no	yes	40	E
Classe d'UPS	001 : off line / line interactive 011 : on line - unitary/parallel 100 : on line – parallel with NS 101 : on line – hot standby redundancy		41	1 to 3
Manual bypass present	absent	present	41	5
Manual bypass switch (Q3BP)	open	closed	41	6
Mode ECO = 1	no	yes	41	7
Battery present	absent	present	42	0
Battery test	no	yes	42	2
Fuse fault	absent	present	42	B
Over temperature	absent	present	42	A & D
Circuit breaker fuse fault	open	close	42	E
Circuit breaker QF1 status	open	close	42	F
Timer expired	absent	present	43	3
Buck mode	no	yes	44	0
Mode Boost mode	no	yes	44	1
Wiring fault	absent	present	44	2
Circuit breaker Q1 status	open	close	44	3
Mains 1 voltage out of tolerance	no	yes	44	8
Mains 1 fuse fault	no	yes	44	9
Charger over temperature fault	absent	present	44	A
Mains 1 frequency out of tolerance	no	yes	44	B
Redundancy lost	no	yes	45	7
Maintenance position	no	yes	46	1

<i>Status description</i>	<i>Status to 0</i>	<i>Status to 1</i>	<i>Word (hex)</i>	<i>Bit</i>
Mains 2 overload	no	yes	46	5
Mains 2 thermal overload	no	yes	46	6
Output on bypass	no	yes	46	7
Mains 2 frequency out of tolerance	no	yes	46	9
Mains 2 voltage out of tolerance	no	yes	46	A
Phase M2 out of tolerance	no	yes	46	B
Circuit breaker Q4S status	open	close	46	E
Internal fault	absent	present	47	0
Synchronization source			47	1 & 8
Mains 2 internal fault	absent	present	47	2
Charger general fault	no	yes	49	0
Battery charge	no	yes	49	1 & 3
Chopper fault	absent	present	4A	1
Rectifier short circuit	absent	present	4A	2
Inverter major fault	no	yes	4C	1
Inverter overload	no	yes	4C	2
Inverter thermal overload	no	yes	4C	3
Inverter limitation	no	yes	4C	4
UPS fuse fault	absent	present	4C	5
Over temperature	absent	present	4C	A
Short circuit	no	yes	4F	1
Output frequency out of range	no	yes	50	5
Electronic power supply fault	no	yes	50	6

6.11.2 Measurements table

<i>Description of the physical quantity</i>	<i>Word (hex)</i>	<i>Unit</i>
I1 (I phase 1) mains 1	100	A
I2 (I phase 2) mains 1	101	A
I3 (I phase 3) mains 1	102	A
I1 (I phase 1) mains 2	106	A
I2 (I phase 2) mains 2	107	A
I3 (I phase 3) mains 2	108	A
I1 (I phase 1) output	109	A
I2 (I phase 2) output	10A	A
I3 (I phase 3) output	10B	A
I battery	10E	A
Nominal value active power	111	W of KW
U12 mains 1	115	V
U23 mains 1	116	V
U31 mains 1	117	V
U mains 2 (phase 1)	11E	V
U mains 2 (phase 2)	11F	V
U mains 2 (phase 3)	120	V
U12 mains 2	121	V
U23 mains 2	122	V
U31 mains 2	123	V
U1N output	124	V
U2N output	125	V
U3N output	126	V
U12 output	127	V
U23 output	128	V
U31 output	129	V
U battery	12D	V
Output active power (phase 1)	130	W
Output active power (phase 2)	131	W
Output active power (phase 3)	132	W
Output apparent power (phase 1)	133	VA
Output apparent power (phase 2)	134	VA
Output apparent power (phase 3)	135	VA
Output total active power	136	W
Output total apparent power	137	VA
% output load level	139	%
Peak factor phase 1 x 100	13A	-
Peak factor phase 2 x 100	13B	-
Peak factor phase 3 x 100	13C	-

<i>Description of the physical quantity</i>	<i>Word (hex)</i>	Unit
Power factor x 100	13D	-
Mains 1 frequency	13E	Hz
Mains 2 frequency	140	Hz
Output frequency	141	Hz
Battery backup time	149	Min
Battery charging level	14B	%
U mains 1 (phase 1)	150	V
U mains 1 (phase 2)	151	V
U mains 1 (phase 3)	152	V
Nominal value apparent power	209	VA or KVA
Nominal voltage of battery element	213	V

6.12 Sensor data

6.12.1 Status table

<i>Status description</i>	<i>Status to 0</i>	<i>Status to 1</i>	<i>Word (hex)</i>	Bit
Input 1 alarm	No	yes	45	5
Input 2 alarm	No	yes	45	6
Alarm : humidity too low	no	yes	45	4
Alarm : humidity too high	no	yes	45	3
Alarm : temperature too low	no	yes	45	2
Alarm : temperature too high	no	yes	45	1
Communication fault	no	yes	45	0
Input 1	open	close	48	0
Input 2	open	close	48	1

6.12.2 Measurements table

<i>Description of the physical quantity</i>	<i>Word (hex)</i>	Unit
Temperature measure	180	°C / °F
Maximum temperature	181	°C / °F
Maximum temperature date (MSB) in Unix timestamp	182	
Maximum temperature date (LSB) in Unix timestamp	183	
Minimum temperature	184	°C / °F
Minimum temperature date (MSB) in Unix timestamp	185	
Minimum temperature date (LSB) in Unix timestamp	186	
Humidity measure	187	%
Maximum humidity	188	%
Maximum humidity date (MSB) in Unix timestamp	189	
Maximum humidity date (LSB) in Unix timestamp	18A	
Minimum humidity	18B	%
Minimum humidity date (MSB) in Unix timestamp	18C	
Minimum humidity date (LSB) in Unix timestamp	18D	
Input 1 changing date (MSB) in Unix timestamp	194	
Input 1 changing date (LSB) in Unix timestamp	195	
Input 2 changing date (MSB) in Unix timestamp	196	
Input 2 changing date (LSB) in Unix timestamp	197	

6.12.3 Read of the personalization table

<i>Description</i>	<i>Word (hex)</i>	Unit
High threshold temperature (°C)	32C	0
Low threshold temperature (°C)	32D	0
Temperature hysteresis (°C)	32E	0
Offset temperature (deci °C)	32F	0
High threshold humidity (%)	330	0
Low threshold humidity (%)	331	0
Humidity hysteresis (%)	332	0
Humidity offset (‰)	333	0
Inputs call mask – input 1 close notification	334	0
Inputs call mask – input 1 open notification	334	1
Inputs call mask – input 2 close notification	334	2
Inputs call mask – input 2 open notification	334	3
Inputs call mask – high temperature notification	334	4
Inputs call mask – low temperature notification	334	5
Inputs call mask – high temperature shutdown	334	6
Inputs call mask – low temperature shutdown	334	7
Inputs call mask – high humidity notification	334	8
Inputs call mask – low humidity notification	334	9
Inputs call mask – high humidity shutdown	334	A
Inputs call mask – low humidity shutdown	334	B
Inputs call mask – input 1 close shutdown	334	C
Inputs call mask – input 1 open shutdown	334	D
Inputs call mask – input 2 close shutdown	334	E
Inputs call mask – input 2 open shutdown	334	F
Input 1 identification	336 - 343	
Input 2 identification	344 - 351	

6.13 Other data

<i>Information description</i>	<i>Word (hex)</i>	Example
Manufacturer name	1A0 – 1A7	“Eaton”
Product name	1A8 – 1AF	“Pulsar”
UPS model	1B0 – 1B7	“700”
Serial number	1B8 – 1BF	“AN2E49008”
Part number	1C0 – 1C7	
Reference number	1C8 – 1CF	

7 Glossary